

**UNIVERSAL 320
UNIVERSAL 320 R**



(DE)	Bedienungsanleitung	9
(EN)	Operating Instructions	30
(FR)	Mode d'emploi	51
(IT)	Istruzioni per l'uso	72

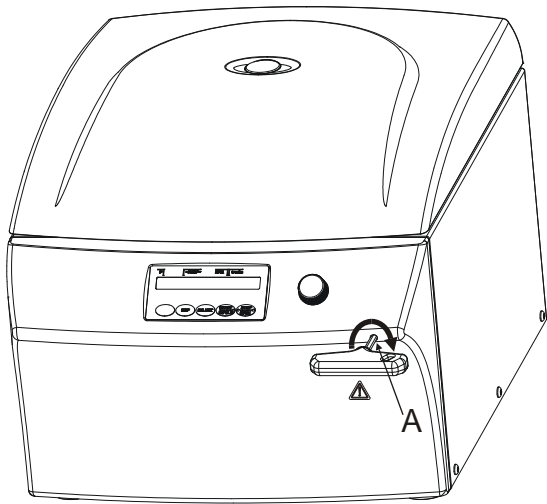

Fig. 1

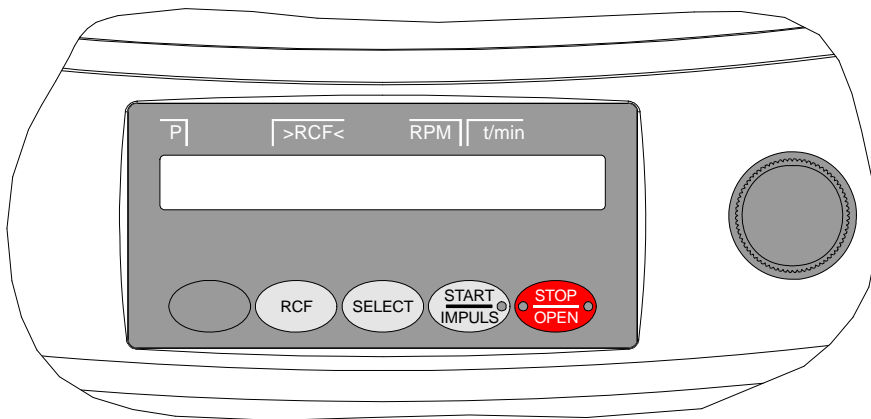

Fig. 2 UNIVERSAL 320

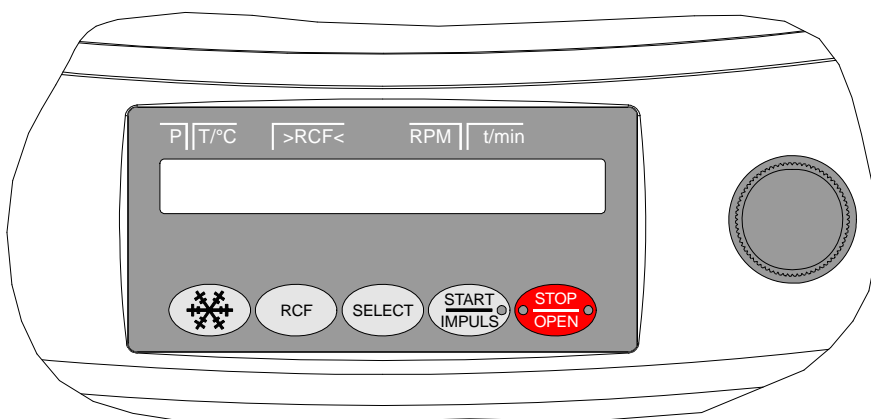

Fig. 3 UNIVERSAL 320 R

EG-Konformitätserklärung
EC Declaration of conformity
Déclaration de conformité CE
Dichiarazione di conformità CE

des Herstellers / of the manufacturer / du fabricant / del costruttore
Andreas Hettich GmbH & Co. KG • Föhrenstraße 12 • D-78532 Tuttlingen • Germany

Hiermit erklären wir in alleiniger Verantwortung, dass das bezeichnete Gerät, inklusive dem mit dem Gerät konformitätsbewertetem Zubehör laut Zubehörliste der technischen Dokumentation dieses Geräts, der Richtlinie über In-vitro-Diagnostika 98/79/EG entspricht.

We hereby declare that we are solely responsible that the designated device and its accessories listed in the technical documentation for this device are in accordance with Directive 98/79/EC on in vitro diagnostic medical devices.

Par la présente, nous déclarons sous notre seule responsabilité que l'appareil désigné, incluant ses accessoires attestés conformes d'après la liste des accessoires de la documentation technique du dit-appareil, répond à la directive 98/79/CE sur le diagnostic In-vitro.

Si dichiara nella nostra sola responsabilità, che l'apparecchiatura indicata, comprensiva dei conformi accessori come da elenco della documentazione tecnica di questa apparecchiatura, risponde alle direttive per Diagnostica In-Vitro 98/79/CE.

Geräteart / Type of device / Type d'appareil / Tipo di apparecchio:

Laborzentrifuge / Laboratory centrifuge / Centrifugeuse de laboratoire / Centrifuga di laboratorio

Typenbezeichnung / Type designation / Désignation du type / Denominazione del tipo:

UNIVERSAL 320 / UNIVERSAL 320 R

Das Konformitätsbewertungsverfahren wurde nach Anhang III der Richtlinie 98/79/EG durchgeführt.

The conformity evaluation process was performed in accordance with appendix III of Directive 98/79/EC.

La procédure d'évaluation de la conformité a été réalisée conformément à l'annexe III de la directive 98/79/CE.

La procedura di valutazione di conformità è stata eseguita conformemente all'appendice III delle direttive 98/79/CE.

Angewandte Normen und Richtlinien:

Gemäß Liste der angewandten Normen und mitgeltenden Richtlinien, die Teil der Produktakte ist.

Applied standards and directives:

According to the list of applied standards and valid directives which is part of the product documentation.

Normes et directives appliquées:

Conformément à la liste des normes et directives applicables et appliquées qui font partie du dossier relatif au produit.

Norme e direttive applicate:

Conformemente alla lista delle norme applicate e delle direttive di validità, che sono parte degli atti del prodotto.

Tuttlingen, 2009-07-16



H. Eberle
Geschäftsführer, Manager,
Directeur, Gerente



Hettich
LAB TECHNOLOGY

Für Hettich Zentrifugen gültige Normen und Vorschriften

Hettich Zentrifugen sind Produkte mit einem sehr hohen technischen Niveau. Sie unterliegen umfangreichen Prüf- und Zertifizierungsverfahren gemäß folgenden Normen und Vorschriften in deren jeweils gültigen Fassung:

Elektrische und mechanische Sicherheit für Konstruktion und Endprüfung:

Normbaureihe: IEC 61010 (entspricht der Normenreihe DIN EN 61010)

- IEC 61010-1 "Sicherheitsbestimmungen für elektrische Mess-, Steuer-, Regel- und Laborgeräte - Teil 1: Allgemeine Anforderungen" (Verschmutzungsgrad 2, Installationskategorie II)
- IEC 61010-2-010 "Sicherheitsbestimmungen für elektrische Mess-, Steuer-, Regel- und Laborgeräte – Teil 2-010: Besondere Anforderungen an Laborgeräte für das Erhitzen von Stoffen (nur für Zentrifugen mit Heizung gültig)
- IEC 61010-2-020 "Sicherheitsbestimmungen für elektrische Mess-, Steuer-, Regel- und Laborgeräte - Teil 2-020: Besondere Anforderungen an Laborzentrifugen
- IEC 61010-2-101 "Sicherheitsbestimmungen für elektrische Mess-, Steuer-, Regel- und Laborgeräte - Teil 2-101: Besondere Anforderungen an In-vitro-Diagnostik (IVD) Medizingeräte

Elektromagnetische Verträglichkeit:

- EN 61326-1 "Elektrische Mess-, Steuer-, Regel- und Laborgeräte - EMV-Anforderungen - Teil 1: Allgemeine Anforderungen

Die EMV-Norm bezieht sich auf die folgenden Querschnittsnormen:

Emission:

- leitungsgebundene Emission EN 55011 Klasse B
- abgestrahlte Emission EN 55011 Klasse B
- Oberschwingungsstrom-Emission EN 61000-3-2
- Spannungsschwankungen EN 61000-3-3

Unempfindlichkeit gegenüber:

- Entladung statischer Elektrizität EN 61000-4-2
- elektromagnetischen Feldern EN 61000-4-3
- schnellen transienten elektrischen Störgrößen/Burst EN 61000-4-4
- Stoßspannungen EN 61000-4-5
- leitungsgeführten Störgrößen, induziert durch hochfrequente Felder EN 61000-4-6
- Magnetfeldern EN 61000-4-8
- Spannungseinbrüchen und Kurzzeitunterbrechungen EN 61000-4-11

Für Konformitätsbewertungsverfahren geltende Europäische Richtlinien:

Richtlinie 98/79/EC über In-vitro-Diagnosegeräte

EG-Konformitätsbewertungsverfahren gemäß Anhang III "EG-Konformitätserklärung" – Eigenerklärung des Herstellers

Weitere, mitgeltende europäische Richtlinien:

- Maschinenrichtlinie 2006/42/EG
- EMV-Richtlinie 2004/108/EG
- Niederspannungsrichtlinie 2006/95/EC

Außerhalb Europas geltende Richtlinien für Medizinprodukte:

- **USA:** QSR, 21CFR 820 "CFR Title 21 - Food and Drugs: TITLE 21- FOOD AND DRUGS, CHAPTER I - FOOD AND DRUG ADMINISTRATION DEPARTMENT OF HEALTH AND HUMAN SERVICES, SUBCHAPTER H - MEDICAL DEVICES, Part 820 QUALITY SYSTEM REGULATIONS"
- **Kanada:** CMDR, SOR/98-282 "Medical Devices Regulations"

Zertifiziertes Qualitätsmanagementsystem gemäß

- ISO 9001 "Qualitätsmanagementsysteme - Anforderungen"
- ISO13485 "Qualitätsmanagementsysteme für Medizinprodukte - Anforderungen für regulatorische Zwecke"

Umweltmanagementsystem gemäß

- ISO 14001 "Umweltmanagementsysteme - Spezifikation mit Anleitung zur Anwendung"

Standards and regulations applied to Hettich centrifuges

Hettich centrifuges are high-end technical products. They are subject to extensive testing and certification procedures according to following standards and regulations applied in their current versions:

Electrical and mechanical safety for design and final testing:

Standard series: IEC 61010 (conform to standards of DIN EN 61010)

- IEC 61010-1 "Safety requirements for electrical equipment for measurement, control, and laboratory use - Part 1: General requirements" (Pollution Degree 2, Installation Category II)
- IEC 61010-2-010 "Safety requirements for electrical equipment for measurement, control and laboratory use - Part 2-010: Particular requirements for laboratory equipment for the heating of materials" (applied to heated centrifuges only)
- IEC 61010-2-020 "Safety requirements for electrical equipment for measurement, control, and laboratory use - Part 2-020: Particular requirements for laboratory centrifuges"
- IEC 61010-2-101 "Safety requirements for electrical equipment for measurement, control and laboratory use - Part 2-101: Particular requirements for in vitro diagnostic (IVD) medical equipment"

Electromagnetic Compatibility:

- EN 61326-1 "Electrical equipment for measurement, control and laboratory use - EMC requirements - Part 1: General requirements"

The EMC standard refers to the following generic standards:

Emission:

- | | |
|------------------------------------|------------------|
| • Conducted emission | EN 55011 Class B |
| • Radiated emission | EN 55011 Class B |
| • Harmonic current emissions | EN 61000-3-2 |
| • Voltage fluctuations and flicker | EN 61000-3-3 |

Immunity to...

- | | |
|--|---------------|
| • Electrostatic discharge | EN 61000-4-2 |
| • Electromagnetic fields | EN 61000-4-3 |
| • Electrical fast transients (Burst) | EN 61000-4-4 |
| • Surge | EN 61000-4-5 |
| • Conducted RF disturbances | EN 61000-4-6 |
| • Magnetic field | EN 61000-4-8 |
| • Voltage dips and short interruptions | EN 61000-4-11 |

European directives applied for conformity assessment procedures:

In vitro diagnostic device directive 98/79/EG

EC conformity assessment procedure according to annex III "EC DECLARATION OF CONFORMITY" – self-declaration by the manufacturer

Further partly applicable European directives:

- Machinery Directive 2006/42/EC
- EMC directive 2004/108/EC
- Low voltage directive 2006/95/EC

Applied medical device regulations outside Europe:

- **USA:** QSR, 21CFR 820 "CFR Title 21 - Food and Drugs: TITLE 21 - FOOD AND DRUGS, CHAPTER I - FOOD AND DRUG ADMINISTRATION DEPARTMENT OF HEALTH AND HUMAN SERVICES, SUBCHAPTER H - MEDICAL DEVICES, Part 820 QUALITY SYSTEM REGULATIONS"
- **Canada:** CMDR, SOR/98-282 "Medical Devices Regulations"

Certified quality management system according to

- ISO 9001 "Quality management systems – Requirements"
- ISO13485 "Medical devices - Quality management systems - Requirements for regulatory purposes"

Environmental management system according to

- ISO 14001 "Environmental management systems - Requirements with guidance for use"

Normes et prescriptions valables pour centrifugeuses Hettich

Les centrifugeuses Hettich sont des produits possédant un niveau technique très élevé. Elles sont soumises à des procédures de vérification et de certification, d'après les normes et prescriptions suivantes, dans leur version actuelle:

Sécurité électrique et mécanique pour la construction et l'inspection finale :

Série de normes : IEC 61010 (correspond à la série de norme DIN EN 61010)

- IEC 61010-1 "Règles de sécurité pour appareils électriques de mesure, de régulation et de laboratoire - partie 1 : Prescriptions générales" (niveau de sécurité 2, catégorie d'installation II)
- IEC 61010-2-010 "Règles de sécurité pour appareils électriques de mesure, de régulation et de laboratoire – partie 2-010 : Prescriptions particulières pour appareils de laboratoire utilisés pour l'échauffement des matières (seulement valable pour centrifugeuses avec chauffage)
- IEC 61010-2-020 "Règles de sécurité pour appareils électriques de mesure, de régulation et de laboratoire – partie 2-020 : Prescriptions particulières pour centrifugeuses de laboratoire
- IEC 61010-2-101 "Règles de sécurité pour appareils électriques de mesure, de régulation et de laboratoire – partie 2-101 : Prescriptions particulières pour les appareils médicaux de diagnostic in vitro (DIV)

Compatibilité électromagnétique :

- EN 61326-1 "Matériel électrique de mesure, de commande et de laboratoire – Exigences relatives à la CEM - partie 1 : Exigences générales

Les normes CEM se rapportent aux normes génériques suivantes :

émission :

- | | |
|----------------------------------|-------------------|
| • émission par conduction | EN 55011 classe B |
| • émission émise | EN 55011 classe B |
| • émission de courant harmonique | EN 61000-3-2 |
| • variations de tension | EN 61000-3-3 |

Immunité aux :

- | | |
|--|---------------|
| • décharges électrostatiques | EN 61000-4-2 |
| • champs électromagnétiques | EN 61000-4-3 |
| • perturbations/Burst transitoires électriques rapides | EN 61000-4-4 |
| • ondes de choc | EN 61000-4-5 |
| • perturbations conduites, induites par les champs à haute fréquence | EN 61000-4-6 |
| • champs magnétiques | EN 61000-4-8 |
| • creux de tension et coupures brèves | EN 61000-4-11 |

Directives européennes valables pour des procédures d'évaluation de la conformité :

directive 98/79/EC relative aux dispositifs médicaux de diagnostic in vitro
procédure d'évaluation de la conformité CE d'après l'annexe III "Déclaration CE de conformité" – déclaration spécifique du fabricant

Autres directives européennes partiellement valables :

- directive 2006/42/EG relative aux machines
- directive CEM 2004/108/EG
- directive basse tension 2006/95/EC

Directives pour dispositifs médicaux, valables en dehors de l'Europe :

- **USA** : QSR, 21CFR 820 "CFR Title 21 - Food and Drugs : TITLE 21- FOOD AND DRUGS, CHAPTER I - FOOD AND DRUG ADMINISTRATION DEPARTMENT OF HEALTH AND HUMAN SERVICES, SUBCHAPTER H - MEDICAL DEVICES, Part 820 QUALITY SYSTEM REGULATIONS"
- **Canada**: CMDR, SOR/98-282 "Medical Devices Regulations"

Système de management de la qualité certifié d'après

- ISO 9001 "Systèmes de management de la qualité - Prescriptions"
- ISO 13485 "Dispositifs médicaux - Systèmes de management de la qualité - Exigences à des fins réglementaires"

Système de management environnemental d'après

- ISO 14001 "Systèmes de management environnemental - Spécification avec description pour application"

Norme e direttive valide per le centrifughe Hettich

Le centrifughe Hettich sono prodotti di elevatissimo livello tecnico. Esse sono sottoposte ad ampi procedimenti di collaudo e di certificazione, in conformità alle seguenti norme e direttive nella corrispondente versione di validità:

Sicurezza elettrica e meccanica per la costruzione ed il collaudo finale:

Serie di norma: IEC 61010 (corrisponde alla serie di norma DIN EN 61010)

- IEC 61010-1 "Norme di sicurezza per apparecchiature elettriche di misurazione, di comando, di regolazione e di laboratorio - parte 1: Requisiti generali" (grado di imbrattamento 2, categoria di installazione II)
- IEC 61010-2 -010 "Norme di sicurezza per apparecchiature elettriche di misurazione, di comando, di regolazione e di laboratorio - parte 2-010: Requisiti particolari per le apparecchiature di laboratorio per il riscaldamento di materiali (valido solo per centrifughe con riscaldamento)
- IEC 61010-2 -020 "Norme di sicurezza per apparecchiature elettriche di misurazione, di comando, di regolazione e di laboratorio - parte 2-020: Requisiti particolari per centrifughe di laboratorio
- IEC 61010-2 -101 "Norme di sicurezza per apparecchiature elettriche di misurazione, di comando, di regolazione e di laboratorio - parte 2-101: Requisiti particolari per la diagnostica In-vitro (IVD) apparecchiature medicali

Compatibilità elettromagnetica:

- EN 61326-1 "Apparecchiature elettriche di misurazione, di comando, di regolazione e di laboratorio - requisiti di compatibilità elettromagnetica - parte 1: Requisiti generali

La norma di compatibilità elettromagnetica si riferisce alle seguenti norme:

Emissione:

- | | |
|--|-------------------|
| • Emissione legata al conduttore | EN 55011 classe B |
| • Emissione irradiata | EN 55011 classe B |
| • Emissione per corrente di armonica superiore | EN 61000-3-2 |
| • Oscillazioni di tensione | EN 61000-3-3 |

Insensibilità nei confronti di:

- | | |
|---|---------------|
| • Scarica di elettricità statica | EN 61000-4-2 |
| • Campi elettromagnetici | EN 61000-4-3 |
| • veloci transienti elettrici di entità di interferenza/Burst | EN 61000-4-4 |
| • Tensioni impulsive | EN 61000-4-5 |
| • Entità di interferenza condotte dai cavi, indotte tramite campi ad alta frequenza | EN 61000-4-6 |
| • Campi magnetici | EN 61000-4-8 |
| • Interruzioni di tensione ed interruzioni temporanee | EN 61000-4-11 |

Direttive europee che sono di validità per il procedimento di valutazione della conformità:

Direttive 98/79/CE per apparecchiature di diagnosi In-vitro

Procedimento di valutazione di conformità CE conforme all'appendice III "Dichiarazione di conformità CE" – Dichiarazione propria del costruttore

Ulteriori direttive europee, che sono in parte di validità:

- Direttive per macchine 2006/42/CE
- Direttive per compatibilità elettromagnetica 2004/108/CE
- Direttive per basse tensioni 2006/95/CE

Direttive valide al di fuori dell'ambito europeo per i prodotti medicali:

- **USA:** QSR, 21CFR 820 "CFR Title 21 - Food and Drugs: TITLE 21- FOOD AND DRUGS, CHAPTER I - FOOD AND DRUG ADMINISTRATION DEPARTMENT OF HEALTH AND HUMAN SERVICES, SUBCHAPTER H - MEDICAL DEVICES, Part 820 QUALITY SYSTEM REGULATIONS"
- **Kanada:** CMDR, SOR/98-282 "Medical Devices Regulations"

Certificato sistema di gestione della qualità, conforme a

- ISO 9001 "Requisiti per sistemi di gestione qualità"
- ISO13485 "Sistemi di gestione qualità per prodotti medicali - Requisiti per impieghi di regolazione"

Sistema di gestione ambientale, conforme a

- ISO 14001 "Sistemi di gestione ambientale - Specificazione con istruzioni per l'applicazione"

Andreas Hettich GmbH & Co. KG
Föhrenstraße 12, D-78532 Tuttlingen / Germany
Phone +49 (0)7461 / 705-0
Fax +49 (0)7461 / 705-125
info@hettichlab.com, service@hettichlab.com
www.hettichlab.com



© 2005 by Andreas Hettich GmbH & Co. KG

All rights reserved. No part of this publication may be reproduced without the prior written permission of the copyright owner.

Änderungen vorbehalten! , Modifications reserved! , Sous réserve de modifications ! , Con riserva di modifiche!

AB1401DEENFRIT / Rev. 01 / 11.11

Inhaltsverzeichnis

1	Bestimmungsgemäße Verwendung.....	11
2	Restrisiken.....	11
3	Technische Daten.....	11
4	Sicherheitshinweise.....	14
5	Bedeutung der Symbole.....	16
6	Lieferumfang.....	16
7	Auspacken der Zentrifuge.....	16
8	Inbetriebnahme.....	17
9	Deckel öffnen und schließen.....	17
9.1	Deckel öffnen.....	17
9.2	Deckel schließen.....	17
10	Ein- und Ausbau des Rotors.....	18
11	Beladen des Rotors.....	18
12	Verschließen von Bio-Sicherheitssystemen.....	19
13	Bedien- und Anzeigeelemente.....	19
13.1	Drehknopf.....	19
13.2	Tasten des Bedienfeldes.....	19
13.3	Einstellmöglichkeiten.....	20
14	Zentrifugations-Parameter eingeben.....	20
15	Programmierung.....	21
15.1	Programm -Eingabe / -Änderung.....	21
15.2	Programm-Abruf.....	21
16	Zentrifugation.....	21
16.1	Zentrifugation mit Zeitvorwahl.....	21
16.2	Dauerlauf.....	22
16.3	Kurzzeitzentrifugation.....	22
17	Not-Stop.....	22
18	Akustisches Signal.....	22
19	Betriebsstunden-Abfrage.....	22
20	Kühlung (nur bei Zentrifuge mit Kühlung).....	23
20.1	Standby-Kühlung.....	23
20.2	Vorkühlen des Rotors.....	23
21	Relative Zentrifugalbeschleunigung (RCF).....	23
22	Zentrifugation von Stoffen oder Stoffgemischen mit einer höheren Dichte als 1,2 kg/dm ³	24
23	Rotorerkennung.....	24
24	Notentriegelung.....	24
25	Pflege und Wartung.....	25
25.1	Zentrifuge (Gehäuse, Deckel und Schleuderraum).....	25
25.1.1	Oberflächenreinigung und -pflege.....	25
25.1.2	Oberflächendesinfektion.....	25
25.1.3	Entfernen radioaktiver Verunreinigungen.....	25

25.2	Rotoren und Zubehör	26
25.2.1	Reinigung und Pflege	26
25.2.2	Desinfektion	26
25.2.3	Entfernen radioaktiver Verunreinigungen.....	26
25.2.4	Tragzapfen.....	26
25.2.5	Rotoren und Zubehör mit begrenzter Verwendungsdauer	27
25.3	Autoklavieren	27
25.4	ZentrifugiergefäÙe.....	27
26	Störungen.....	28
27	Rücksendung von Geräten.....	29
28	Entsorgung.....	29
29	Anhang / Appendix	93
29.1	Rotoren und Zubehör / Rotors and accessories.....	93

1 Bestimmungsgemäße Verwendung

Bei dem vorliegenden Gerät handelt es sich um ein Medizinprodukt (Laborzentrifuge) im Sinne der IVD-Richtlinie 98/79/EG.

Die Zentrifuge dient zum Trennen von Stoffen bzw. Stoffgemischen mit einer Dichte von max. 1,2 kg/dm³. Darunter fallen insbesondere Proben zur Vorbereitung für In-vitro diagnostische Zwecke in der Humanmedizin.

Die Zentrifuge ist nur für diesen Verwendungszweck bestimmt.

Eine andere oder darüber hinausgehende Benutzung gilt als nicht bestimmungsgemäß. Für hieraus entstehende Schäden haftet die Firma Andreas Hettich GmbH & Co. KG nicht.

Zur bestimmungsgemäßen Verwendung gehört auch das Beachten aller Hinweise aus der Bedienungsanleitung und die Einhaltung der Inspektions- und Wartungsarbeiten.

2 Restrisiken

Das Gerät ist nach dem Stand der Technik und den anerkannten sicherheitstechnischen Regeln gebaut. Bei unsachgemäßer Verwendung und Behandlung können Gefahren für Leib und Leben des Benutzers oder Dritter bzw. Beeinträchtigungen an dem Gerät oder an anderen Sachwerten entstehen. Das Gerät ist nur für die bestimmungsgemäße Verwendung, und nur in sicherheitstechnisch einwandfreiem Zustand zu benutzen.

Störungen, die die Sicherheit beeinträchtigen können, sind umgehend zu beseitigen.

3 Technische Daten

Hersteller	Andreas Hettich GmbH & Co. KG D-78532 Tuttlingen				
Modell	UNIVERSAL 320		UNIVERSAL 320 R		
Typ	1401	1401-01	1406	1406-01	
Netzspannung ($\pm 10\%$)	200-240 V 1~	100-127 V 1~	200-240 V 1~	240 V 1~	115-127 V 1~
Netzfrequenz	50 – 60 Hz	50 – 60 Hz	50 Hz	60 Hz	60 Hz
Anschlusswert	400 VA	400 VA	800 VA		950 VA
Stromaufnahme	2.0 A	4.0 A	4.0 A		8.0 A
Kältemittel	----		R 404A		
Kapazität max.	4 x 100 ml				
zulässige Dichte	1.2 kg/dm ³				
Drehzahl (RPM)	15000				
Beschleunigung (RCF)	21382				
Kinetische Energie	8600 Nm				
Prüfpflicht (BGR 500)	nein				
Umgebungsbedingungen (EN / IEC 61010-1)	<p>nur in Innenräumen bis zu 2000 m über Normal-Null</p> <p>2°C bis 35°C 5°C bis 35°C</p> <p>maximale relative Luftfeuchte 80% für Temperaturen bis 31°C, linear abnehmend bis 50% relativer Luftfeuchte bei 40°C.</p>				
– Aufstellungsort					
– Höhe					
– Umgebungstemperatur					
– Luftfeuchtigkeit					
– Überspannungskategorie (IEC 60364-4-443)	II				
– Verschmutzungsgrad	2				
Geräteschutzklasse	I				
nicht für den Einsatz in explosionsgefährdeter Umgebung geeignet.					
EMV					
– Störaussendung, Störfestigkeit	EN / IEC 61326-1, Klasse B	FCC Class B	EN / IEC 61326-1, Klasse B	FCC Class B	
Geräuschpegel (rotorabhängig)	≤ 68 dB(A)		≤ 58 dB(A)		
Abmessungen					
– Breite	395 mm		401 mm		
– Tiefe	520 mm		695 mm		
– Höhe	346 mm		346 mm		
Gewicht	ca. 31 kg		ca. 53 kg	ca. 52 kg	

Hersteller	Andreas Hettich GmbH & Co. KG D-78532 Tuttlingen			
Modell	UNIVERSAL 320 R			
Typ	1406-50	1406-51	1406-70	1406-71
Netzspannung ($\pm 10\%$)	200-240 V 1~	100-127 V 1~	200-240 V 1~	100-127 V 1~
Netzfrequenz	50 – 60 Hz	50 – 60 Hz	50 – 60 Hz	50 – 60 Hz
Anschlusswert	400 VA	400 VA	400 VA	400 VA
Stromaufnahme	2.0 A	4.0 A	2.0 A	4.0 A
Kapazität max.	4 x 100 ml			
zulässige Dichte	1.2 kg/dm ³			
Drehzahl (RPM)	15000			
Beschleunigung (RCF)	21382			
Kinetische Energie	8600 Nm			
Prüfpflicht (BGR 500)	nein			
Umgebungsbedingungen (EN / IEC 61010-1)	<p>nur in Innenräumen bis zu 2000 m über Normal-Null 2°C bis 35°C maximale relative Luftfeuchte 80% für Temperaturen bis 31°C, linear abnehmend bis 50% relativer Luftfeuchte bei 40°C.</p>			
– Aufstellungsort				
– Höhe				
– Umgebungstemperatur				
– Luftfeuchtigkeit				
– Überspannungskategorie (IEC 60364-4-443)	II			
– Verschmutzungsgrad	2			
Geräteschutzklasse	I			
nicht für den Einsatz in explosionsgefährdeter Umgebung geeignet.				
EMV				
– Störaussendung, Störfestigkeit	EN / IEC 61326-1, Klasse B	FCC Class B	EN / IEC 61326-1, Klasse B	FCC Class B
Geräuschpegel (rotorabhängig)	≤ 58 dB(A)			
Abmessungen				
– Breite	395 mm			
– Tiefe	520 mm			
– Höhe	346 mm			
Gewicht	ca. 35 kg			

Hersteller	Andreas Hettich GmbH & Co. KG D-78532 Tuttlingen		
Modell	UNIVERSAL 320 R		
Typ	1406-20		1406-21
Netzspannung ($\pm 10\%$)	200-240 V 1~	240 V 1~	115-127 V 1~
Netzfrequenz	50 Hz	60 Hz	60 Hz
Anschlusswert	800 VA		950VA
Stromaufnahme	4.0 A		8.0 A
Kältemittel	R 404A		
Kapazität max.	4 x 100 ml		
zulässige Dichte	1.2 kg/dm ³		
Drehzahl (RPM)	15000		
Beschleunigung (RCF)	21382		
Kinetische Energie	8600 Nm		
Prüfpflicht (BGR 500)	nein		
Umgebungsbedingungen (EN / IEC 61010-1)	<p>nur in Innenräumen bis zu 2000 m über Normal-Null 5°C bis 35°C maximale relative Luftfeuchte 80% für Temperaturen bis 31°C, linear abnehmend bis 50% relativer Luftfeuchte bei 40°C.</p>		
– Aufstellungsort			
– Höhe			
– Umgebungstemperatur			
– Luftfeuchtigkeit			
– Überspannungskategorie (IEC 60364-4-443)	II		
– Verschmutzungsgrad	2		
Geräteschutzklasse	I		
nicht für den Einsatz in explosionsgefährdeter Umgebung geeignet.			
EMV			
– Störaussendung, Störfestigkeit	EN / IEC 61326-1, Klasse B		FCC Class B
Geräuschpegel (rotorabhängig)	≤ 58 dB(A)		
Abmessungen			
– Breite	401 mm		
– Tiefe	695 mm		
– Höhe	346 mm		
Gewicht	ca. 52 kg		

4 Sicherheitshinweise



Werden nicht alle Hinweise in dieser Bedienungsanleitung befolgt, kann beim Hersteller kein Gewährleistungsanspruch geltend gemacht werden.



- Die Zentrifuge ist so aufzustellen, dass sie standsicher betrieben werden kann.
- Vor Benutzung der Zentrifuge unbedingt den Rotor auf festen Sitz prüfen.
- Während eines Zentrifugationslaufes dürfen sich gemäß EN / IEC 61010-2-020, in einem Sicherheitsbereich von 300 mm um die Zentrifuge herum, keine Personen, Gefahrstoffe und Gegenstände befinden.
- Rotoren, Gehänge und Zubehörteile, die starke Korrosionsspuren oder mechanische Schäden aufweisen, oder deren Verwendungsdauer abgelaufen ist, dürfen nicht mehr verwendet werden.
- Die Zentrifuge darf nicht mehr in Betrieb genommen werden, wenn der Schleuderraum sicherheitsrelevante Schäden aufweist.
- Bei Ausschwingrotoren müssen die Tragzapfen regelmäßig gefettet werden (Hettich-Schmierfett Nr. 4051), um ein gleichmäßiges Ausschwingen der Gehänge zu gewährleisten.
- Bei Zentrifugen ohne Temperaturregelung kann es bei erhöhter Raumtemperatur und/oder bei häufigem Gebrauch des Gerätes zur Erwärmung des Schleuderraums kommen. Eine temperaturbedingte Veränderung des Probenmaterials kann deshalb nicht ausgeschlossen werden.

- Vor Inbetriebnahme der Zentrifuge ist die Bedienungsanleitung zu lesen und zu beachten. Nur Personen, die die Bedienungsanleitung gelesen und verstanden haben, dürfen das Gerät bedienen.
- Neben der Bedienungsanleitung und den verbindlichen Regelungen der Unfallverhütung sind auch die anerkannten fachtechnischen Regeln für sicherheits- und fachgerechtes Arbeiten zu beachten. Die Bedienungsanleitung ist um Anweisungen aufgrund bestehender nationaler Vorschriften des Verwenderlandes zur Unfallverhütung und zum Umweltschutz zu ergänzen.
- Die Zentrifuge ist nach dem Stand der Technik gebaut und betriebssicher. Es können aber von ihr Gefahren für den Benutzer oder Dritte ausgehen, wenn sie nicht von geschultem Personal oder unsachgemäß oder zu nicht bestimmungsgemäßem Gebrauch eingesetzt wird.
- Die Zentrifuge darf während des Betriebs nicht bewegt oder angestoßen werden.
- Im Störfall bzw. bei der Notentriegelung nie in den sich drehenden Rotor greifen.
- Um Schäden durch Kondensat zu vermeiden, muss bei Wechsel von einem kalten in einen warmen Raum, die Zentrifuge entweder mindestens 3 Stunden im warmen Raum aufwärmen bevor sie an das Netz angeschlossen werden darf oder 30 Minuten im kalten Raum warmlaufen.
- Es dürfen nur die vom Hersteller für dieses Gerät zugelassenen Rotoren und das zugelassene Zubehör verwendet werden (siehe Kapitel "Anhang/Appendix, Rotoren und Zubehör/Rotors and accessories"). Bevor Zentrifugiergefäße verwendet werden, die nicht in Kapitel "Anhang/Appendix, Rotoren und Zubehör/Rotors and accessories" aufgeführt sind, hat sich der Benutzer beim Hersteller zu vergewissern, ob diese verwendet werden dürfen.
- Der Rotor der Zentrifuge darf nur entsprechend dem Kapitel "Beladen des Rotors" beladen werden.
- Bei der Zentrifugation mit maximaler Drehzahl darf die Dichte der Stoffe oder Stoffgemische $1,2 \text{ kg/dm}^3$ nicht überschreiten.
- Zentrifugationen mit unzulässiger Unwucht sind nicht erlaubt.
- Die Zentrifuge darf nicht in explosionsgefährdeter Umgebung betrieben werden.
- Eine Zentrifugation mit:
 - brennbaren oder explosiven Materialien
 - Materialien, die chemisch mit hoher Energie miteinander reagieren ist verboten.
- Bei der Zentrifugation von gefährlichen Stoffen bzw. Stoffgemischen, die toxisch, radioaktiv oder mit pathogenen Mikroorganismen verseucht sind, sind durch den Benutzer geeignete Maßnahmen zu treffen. Es müssen grundsätzlich Zentrifugiergefäße mit speziellen Schraubverschlüssen für gefährliche Substanzen verwendet werden. Bei Materialien der Risikogruppe 3 und 4 ist zusätzlich zu den verschließbaren

Zentrifugiergefäßen ein Bio-Sicherheitssystem zu verwenden (siehe Handbuch "Laboratory Bio-safety Manual" der Weltgesundheitsorganisation).

Bei einem Bio-Sicherheitssystem verhindert eine Bioabdichtung (Dichtring) das Austreten von Tröpfchen und Aerosolen.

Wird das Gehänge eines Bio-Sicherheitssystems ohne den Deckel verwendet, muss der Dichtring vom Gehänge entfernt werden, um eine Beschädigung des Dichtrings während des Zentrifugationslaufes zu vermeiden. Beschädigte Dichtringe dürfen nicht mehr zum Abdichten des Bio-Sicherheitssystems verwendet werden.

Ohne Verwendung eines Bio-Sicherheitssystems ist eine Zentrifuge im Sinne der Norm EN / IEC 61010-2-020 nicht mikrobiologisch dicht.

Beim Verschließen eines Bio-Sicherheitssystems sind die Anweisungen in Kapitel "Bio-Sicherheitssysteme verschließen" zu befolgen.

Lieferbare Bio-Sicherheitssysteme siehe Kapitel "Anhang/Appendix, Rotoren und Zubehör/Rotors and accessories". Im Zweifelsfall sind entsprechende Informationen beim Hersteller einzuholen.

- Der Betrieb der Zentrifuge mit stark korrodierenden Stoffen, welche die mechanische Festigkeit von Rotoren, Gehängen und Zubehörteilen beeinträchtigen können, ist nicht erlaubt.
- Reparaturen dürfen nur von einer vom Hersteller autorisierten Person ausgeführt werden.
- Es dürfen nur Originalersatzteile und zugelassenes Originalzubehör der Firma Andreas Hettich GmbH & Co. KG verwendet werden.
- Es gelten die folgenden Sicherheitsbestimmungen:
EN / IEC 61010-1 und EN / IEC 61010-2-020 sowie deren nationalen Abweichungen.
- Die Sicherheit und Zuverlässigkeit der Zentrifuge ist nur dann gewährleistet, wenn:
 - die Zentrifuge nach der Bedienungsanleitung betrieben wird.
 - die elektrische Installation, am Aufstellungsort der Zentrifuge, den Anforderungen von EN / IEC Festlegungen entspricht.
 - vorgeschriebene Prüfungen nach BGV A1, BGR 500 durch einen Sachkundigen durchgeführt werden.

5 Bedeutung der Symbole



Symbol am Gerät:
Achtung, allgemeine Gefahrenstelle.
Vor Benutzung des Gerätes unbedingt die Bedienungsanleitung lesen und die sicherheitsrelevanten Hinweise beachten!



Symbol in diesem Dokument:
Achtung, allgemeine Gefahrenstelle.
Dieses Symbol kennzeichnet sicherheitsrelevante Hinweise und deutet auf mögliche gefährliche Situationen hin.
Das Nichtbeachten dieser Hinweise kann zu Sach- und Personenschäden führen.



Symbol am Gerät und in diesem Dokument:
Warnung vor Biogefährdung.



Symbol in diesem Dokument:
Dieses Symbol deutet auf wichtige Sachverhalte hin.



Symbol am Gerät und in diesem Dokument:
Symbol für die getrennte Sammlung von Elektro- und Elektronikgeräten, gemäß der Richtlinie 2002/96/EG (WEEE). Das Gerät gehört zur Gruppe 8 (Medizinische Geräte).
Verwendung in den Ländern der Europäischen Union sowie in Norwegen und der Schweiz.

6 Lieferumfang

- 1 Anschlusskabel
- 1 Sechskant-Stiftschlüssel
- 1 Schmierfett für Tragzapfen
- 1 Bedienungsanleitung
- 1 Hinweisblatt Transportsicherung

Rotor(en) und das entsprechende Zubehör werden je nach Bestellung mitgeliefert.

7 Auspacken der Zentrifuge

- Den Karton nach oben abheben und die Polsterung entfernen.

- | | |
|--|---|
| | Nicht an der Frontblende anheben.
Das Gewicht der Zentrifuge beachten, siehe Kapitel "Technische Daten". |
|--|---|

Die Zentrifuge, mit der angemessenen Anzahl von Helfern, an beiden Seiten anheben und auf den Labortisch stellen.

8 Inbetriebnahme

- Gemäß der Laborgerätenorm EN / IEC 61010-2-020 muss in der Gebäudeinstallation ein Notausschalter zur Trennung der Netzversorgung im Fehlerfall angebracht sein.
Dieser Schalter muss abseits der Zentrifuge angebracht sein, vorzugsweise außerhalb des Raumes, in dem sich die Zentrifuge befindet, oder neben dem Ausgang dieses Raumes.
- Die Transportsicherung am Gehäuseboden entfernen, siehe Hinweisblatt "Transportsicherung".
- **Die Zentrifuge an einem geeigneten Platz standsicher aufstellen und nivellieren. Bei der Aufstellung ist der geforderte Sicherheitsbereich gemäß EN / IEC 61010-2-020, von 300 mm um die Zentrifuge herum, einzuhalten.**



Während eines Zentrifugationslaufes dürfen sich gemäß EN / IEC 61010-2-020, in einem Sicherheitsbereich von 300 mm um die Zentrifuge herum, keine Personen, Gefahrstoffe und Gegenstände befinden.

- Lüftungsöffnungen dürfen nicht zugestellt werden.
Es muss ein Lüftungsabstand von 300 mm um die Lüftungsschlitze oder Lüftungsöffnungen eingehalten werden.
- Bei der Zentrifuge, Best.-Nr. 1406-20, 1406-21, die Stickstoffversorgung gemäß dem beigefügten Hinweisblatt AH1406-20XX anschließen.
Bei der Zentrifuge, Best.-Nr. 1406-50, 1406-51, den Kälte-Umwälzthermostat gemäß dem beigefügten Hinweisblatt AH1406-50XX anschließen
Bei der Zentrifuge, Best.-Nr. 1406-70, 1406-71, den Kälte-Umwälzthermostat und die Stickstoffversorgung gemäß dem beigefügten Hinweisblatt AH1406-70XX anschließen.



Das Anschließen der Zentrifuge muss unbedingt gemäß dem beigefügten Hinweisblatt erfolgen.
Das beigefügte Hinweisblatt unbedingt beachten.

- Prüfen ob die Netzspannung mit der Angabe auf dem Typenschild übereinstimmt.
- Die Zentrifuge mit dem Anschlusskabel an eine genormte Netzsteckdose anschließen. Anschlusswert siehe Kapitel "Technische Daten".
- Den Netzschalter einschalten. Schalterstellung "I".
Der Maschinentyp und die Programmversion werden angezeigt, die LED's leuchten. Nach 8 Sekunden wird **OPEN** / **OEFFNEN** angezeigt und die linke LED in der Taste **STOP / OPEN** blinkt.
- Den Deckel öffnen.
Die zuletzt benutzten Zentrifugierdaten werden angezeigt.

9 Deckel öffnen und schließen

9.1 Deckel öffnen



Der Deckel lässt sich nur öffnen, wenn die Zentrifuge eingeschaltet ist und der Rotor stillsteht.
Sollte dies nicht möglich sein, siehe Kapitel "Notentriegelung".

- Die Taste **OPEN / STOP** drücken. Der Deckel entriegelt motorisch und die linke LED in der Taste **OPEN / STOP** erlischt.

9.2 Deckel schließen



Mit den Fingern nicht zwischen Deckel und Gehäuse greifen.
Den Deckel nicht zuschlagen.

Wenn die linke LED in der Taste **OPEN / STOP** blinkt, die Taste **OPEN / STOP** drücken, dass die motorische Deckelverriegelung die Grundstellung (geöffnet) einnimmt.

- Den Deckel auflegen und die Deckelvorderkante leicht niederdrücken. Die Verriegelung erfolgt motorisch. Die linke LED in der Taste **OPEN / STOP** leuchtet auf.

10 Ein- und Ausbau des Rotors

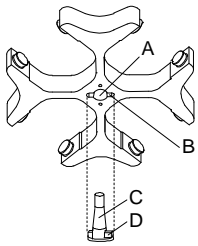

- Die Motorwelle (C) und die Bohrung des Rotors (A) reinigen und anschließend die Motorwelle leicht einfetten. Schmutzpartikel zwischen der Motorwelle und dem Rotor verhindern einen einwandfreien Sitz des Rotors und verursachen einen unruhigen Lauf.
- Den Rotor vertikal auf die Motorwelle aufsetzen. Der Mitnehmer der Motorwelle (D) muss sich in der Nut des Rotors (B) befinden. Auf dem Rotor ist die Ausrichtung der Nut gekennzeichnet.
- Die Spannmutter des Rotors mit dem mitgelieferten Schlüssel durch Drehen im Uhrzeigersinn anziehen.
- Den Rotor auf festen Sitz prüfen.
- Lösen des Rotors: Die Spannmutter durch Drehen entgegen dem Uhrzeigersinn lösen und bis zum Abhebe-Druckpunkt drehen. Nach Überwindung des Abhebe-Druckpunkts löst sich der Rotor vom Konus der Motorwelle. Die Spannmutter drehen, bis sich der Rotor von der Motorwelle abheben lässt.

11 Beladen des Rotors



Standard-Zentrifugiergefäße aus Glas sind belastbar bis RZB 4000 (DIN 58970 Teil 2).

- Den Rotor auf festen Sitz prüfen.
- Bei Ausschwingrotoren müssen alle Plätze des Rotors mit **gleichen** Gehängen besetzt sein. Bestimmte Gehänge sind mit der Nummer des Rotorplatzes gekennzeichnet. Diese Gehänge dürfen nur in den entsprechenden Platz des Rotors eingesetzt werden. Gehänge die mit einer Set-Nummer gekennzeichnet sind, z. B. S001/4, dürfen nur im Set verwendet werden.
- Die Rotoren und Gehänge dürfen nur symmetrisch beladen werden. Die Zentrifugiergefäße müssen gleichmäßig auf alle Plätze des Rotors verteilt werden. Zugelassene Kombinationen siehe Kapitel "Anhang/Appendix, Rotoren und Zubehör/Rotors and accessories".
Bei Winkelrotoren müssen alle möglichen Plätze des Rotors beladen werden, siehe Kapitel "Anhang/Appendix, Rotoren und Zubehör/Rotors and accessories".

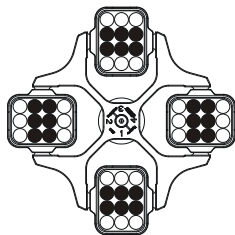

Rotor ist gleichmäßig beladen

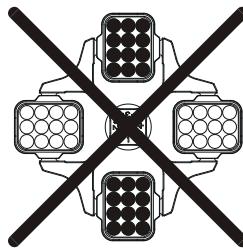

Nicht zulässig!

Rotor ist ungleichmäßig beladen

- Auf bestimmten Gehängen ist das Gewicht der maximalen Beladung oder das Gewicht der maximalen Beladung und das maximale Gewicht des komplett bestückten Gehänges angegeben. Diese Gewichte dürfen nicht überschritten werden. Im Ausnahmefall siehe Kapitel "Zentrifugation von Stoffen oder Stoffgemischen mit einer höheren Dichte als $1,2 \text{ kg/dm}^3$ ". Die Gewichtsangabe der maximalen Beladung umfasst das Gesamtgewicht von Reduzierung, Gestell, Zentrifugiergefäß und Inhalt.
- Bei Behältern mit Gummieinlagen muss sich unter den Zentrifugiergefäßen immer die gleiche Anzahl von Gummieinlagen befinden.
- Die Zentrifugiergefäße immer außerhalb der Zentrifuge befüllen.
- Es darf beim Füllen und beim Ausschwingen der Gehänge keine Flüssigkeit in den Schleuderraum gelangen.
- Die vom Hersteller angegebene maximale Füllmenge der Zentrifugiergefäße darf nicht überschritten werden.
- Um die Gewichtsunterschiede innerhalb der Zentrifugiergefäße möglichst gering zu halten, ist auf eine gleichmäßige Füllhöhe in den Gefäßen zu achten.

12 Verschließen von Bio-Sicherheitssystemen



Um Dichtigkeit zu gewährleisten, muss der Deckel eines Bio-Sicherheitssystems fest verschlossen werden. Um ein Verdrehen des Dichtungsringes während dem Öffnen und Schließen des Deckels zu vermeiden, muss der Dichtungsring mit Talkum-Puder oder einem Gummi-Pflegemittel leicht eingerieben werden.

Wird das Gehänge eines Bio-Sicherheitssystems ohne den Deckel verwendet, muss der Dichtring vom Gehänge entfernt werden, um eine Beschädigung des Dichtrings während des Zentrifugationslaufes zu vermeiden. Beschädigte Dichtringe dürfen nicht mehr zum Abdichten des Bio-Sicherheitssystems verwendet werden.

Lieferbare Bio-Sicherheitssysteme siehe Kapitel "Anhang/Appendix, Rotoren und Zubehör/Rotors and accessories". Im Zweifelsfall sind entsprechende Informationen beim Hersteller einzuholen.

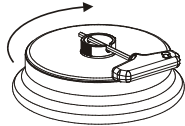

Deckel mit Schraubverschluss und Bohrung im Drehgriff:

- Den mitgelieferten Schlüssel durch die Bohrung im Drehgriff stecken und durch Drehen im Uhrzeigersinn den Deckel fest verschließen.

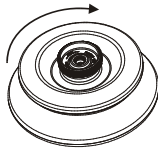

Deckel mit Schraubverschluss, ohne Bohrung im Drehgriff:

- Den Deckel von Hand, durch Drehen im Uhrzeigersinn, fest verschließen.

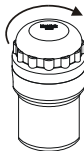

Deckel mit Schraubverschluss:

- Den Deckel von Hand, durch Drehen im Uhrzeigersinn, fest verschließen.

13 Bedien- und Anzeigeelemente

Siehe Abbildung auf Seite 2.

Fig. 2, Fig. 3: Anzeige- und Bedienfeld

13.1 Drehknopf



Zum Einstellen der einzelnen Parameter.

Drehen entgegen dem Uhrzeigersinn erniedrigt den Wert. Drehen im Uhrzeigersinn erhöht den Wert.

13.2 Tasten des Bedienfeldes



- Wähltaste zum Anwählen der einzelnen Parameter. Durch jeden weiteren Tastendruck wird der nachfolgende Parameter angewählt.



- Zentrifugationslauf starten. Die LED in der Taste leuchtet während des Zentrifugationslaufes, solange der Rotor dreht.
- Kurzzeitzentrifugation. Der Zentrifugationslauf erfolgt, solange die Taste gedrückt gehalten wird. Die LED in der Taste leuchtet während des Zentrifugationslaufes, solange der Rotor dreht.
- Eingaben und Änderungen speichern.



- Zentrifugationslauf beenden. Der Rotor läuft mit vorgewählter Bremsstufe aus. Die rechte LED in der Taste leuchtet bis der Rotor stillsteht. Nach Stillstand des Rotors blinkt die linke LED in der Taste. Zweimaliges Drücken der Taste löst den NOT-STOP aus.
- Den Deckel entriegeln. Die linke LED in der Taste erlischt.
- Verlassen der Parametereingabe.



- Umschalten zwischen RPM- und RCF-Anzeige. RCF-Werte werden in > < angezeigt.



- Vorkühlung starten. Die Vorkühl-Drehzahl ist einstellbar. Sie ist voreingestellt auf 2800 RPM.

13.3 Einstellmöglichkeiten

PROG RCL Programmplatz des abzurufenden Programms.

t/min Laufzeit. Einstellbar von 1 - 99 min, in 1 min -Schritten.

t/sec Laufzeit. Einstellbar von 1 - 59 s, in 1 Sekunden-Schritten.

Dauerlauf "∞". Parameter **t/min** und **t/sec** auf Null stellen.

RPM Drehzahl. Einstellbar ist ein Zahlenwert von 500 RPM bis zur maximalen Drehzahl des Rotors. Maximale Drehzahl des Rotors siehe Kapitel "Anhang/Appendix, Rotoren und Zubehör/Rotors and accessories". Einstellbar in 10er Schritten.

RAD/mm Zentrifugerradius. Eingabe in mm. Zentrifugerradius siehe Kapitel "Anhang/Appendix, Rotoren und Zubehör/Rotors and accessories". Die Eingabe des Radius ist nur möglich, wenn die RCF-Anzeige (> RCF <) angewählt ist.

RCF Relative Zentrifugalbeschleunigung. Einstellbar ist ein Zahlenwert, der eine Drehzahl zwischen 500 RPM und der maximalen Drehzahl des Rotors ergibt. Einstellbar bis 100 in 1er Schritten und ab 100 in 10er Schritten. Der RCF-Wert wird automatisch auf den Drehzahlschritt auf- bzw. abgerundet. Die Eingabe der RCF ist nur möglich, wenn die RCF-Anzeige (> RCF <) angewählt ist.



Anlaufstufen 1 - 9. Stufe 9 = kürzeste Anlaufzeit, Stufe 1 = längste Anlaufzeit.



Bremsstufen 0 - 9. Stufe 9 = kürzeste Auslaufzeit, Stufe 1 = lange Auslaufzeit, Stufe 0 = längste Auslaufzeit (ungebremster Auslauf).

T/°C Temperatur-Sollwert (nur bei Zentrifuge mit Kühlung). Einstellbar von -20°C bis +40°C, in 1°C-Schritten. Die tiefste erreichbare Temperatur ist rotorabhängig (siehe Kapitel "Anhang/Appendix, Rotoren und Zubehör/Rotors and accessories").

PROG STO Programmplatz auf dem das Programm gespeichert wird. Es können 9 Programme gespeichert werden (Programmplätze 1 - 2 - 3 - ... 9). Der Programmplatz # dient als Zwischenspeicher für geänderte Einstellungen.

14 Zentrifugations-Parameter eingeben



Wird nach der Auswahl oder während der Eingabe von Parametern 8 Sekunden lang keine Taste gedrückt, werden in der Anzeige wieder die vorherigen Werte angezeigt. Die Eingabe der Parameter muss dann erneut durchgeführt werden.

- Mit der Taste **[RCF]** die RPM- oder RCF-Anzeige anwählen. RCF-Werte werden in > < angezeigt.
- Mit der Taste **[SELECT]** die gewünschten Parameter anwählen und mit dem Drehknopf **⊖** einstellen. Um den Dauerlauf einzustellen müssen die Parameter **t/min** und **t/sec** mit dem Drehknopf **⊖** auf Null gestellt werden. Der Dauerlauf wird in der Anzeige durch das Symbol "∞" angezeigt.
- Nach der Eingabe aller Parameter die Taste **[START/IMPULS]** drücken, um die Einstellungen auf Programmplatz # zu speichern. Als Bestätigung wird kurzzeitig ***** ok ***** angezeigt.



Die Daten auf Programmplatz # werden bei jeder Eingabe von Parametern und Drücken der Taste **[START/IMPULS]** überschrieben.

15 Programmierung

15.1 Programm -Eingabe / -Änderung

 Wird nach der Auswahl oder während der Eingabe von Parametern 8 Sekunden lang keine Taste gedrückt, werden in der Anzeige wieder die vorherigen Werte angezeigt. Die Eingabe der Parameter muss dann erneut durchgeführt werden.

- Mit der Taste **[RCF]** die RPM- oder RCF-Anzeige auswählen. RCF-Werte werden in **> <** angezeigt.
- Mit der Taste **[SELECT]** die gewünschten Parameter auswählen und mit dem Drehknopf **○** einstellen. Um den Dauerlauf einzustellen müssen die Parameter **t/min** und **t/sec** mit dem Drehknopf **○** auf Null gestellt werden. Der Dauerlauf wird in der Anzeige durch das Symbol "∞" angezeigt.
- Mit der Taste **[SELECT]** den Parameter **PROG STO** auswählen und mit dem Drehknopf **○** den gewünschten Programmplatz einstellen.
- Die Taste **[START/IMPULS]** drücken, um die Einstellungen auf dem gewünschten Programmplatz zu speichern. Als Bestätigung wird kurzzeitig ***** ok ***** angezeigt. Wird die Taste **[START/IMPULS]** gedrückt, ohne dass der Parameter **PROG STO** ausgewählt ist, so werden die Einstellungen immer auf Programmplatz # gespeichert.

 Die vorherigen Daten des Programmplatzes werden beim Speichern überschrieben.

15.2 Programm-Abbruch

- Mit der Taste **[SELECT]** den Parameter **PROG RCL** auswählen und mit dem Drehknopf **○** den gewünschten Programmplatz einstellen.
- Die Taste **[START/IMPULS]** drücken. Die Zentrifugations-Daten des ausgewählten Programmplatzes werden angezeigt.
- Die Parameter können durch Drücken der Taste **[SELECT]** überprüft werden. Zum Verlassen der Parameter-Anzeige die Taste **[OPEN/STOP]** drücken oder 8 Sekunden lang keine Taste drücken.

16 Zentrifugation

 Während eines Zentrifugationslaufes dürfen sich gemäß EN / IEC 61010-2-020, in einem Sicherheitsbereich von 300 mm um die Zentrifuge herum, keine Personen, Gefahrstoffe und Gegenstände befinden.

 Wird der zulässige Gewichtsunterschied innerhalb der Beladung des Rotors überschritten, schaltet der Antrieb während des Anlaufs ab, und **IMBALANCE** wird angezeigt. Ein Zentrifugationslauf kann jederzeit durch Drücken der Taste **[OPEN/STOP]** abgebrochen werden. Während des Zentrifugationslaufes können alle Parameter ausgewählt und geändert werden (siehe Kapitel "Zentrifugations-Parameter eingeben"). Mit der Taste **[RCF]** kann jederzeit zwischen der RPM- und RCF-Anzeige umgeschaltet werden. Wird mit der RCF-Anzeige gearbeitet, ist die Eingabe des Zentrifugerradius notwendig. Wird **⚡ OPEN ⚡ OEFFNEN** angezeigt, so ist eine weitere Bedienung der Zentrifuge erst nach einmaligem Öffnen des Deckels möglich. Wird **R xx n-max xxxxx** angezeigt, so hat kein Zentrifugationslauf stattgefunden, weil zuvor der Rotor gewechselt wurde, siehe Kapitel "Rotor-Erkennung".

- Den Netzschalter einschalten. Schalterstellung **I**.
- Den Rotor beladen und den Zentrifugendeckel schließen.

16.1 Zentrifugation mit Zeitvorwahl

- Eine Zeit einstellen oder ein Programm mit Zeitvorwahl abrufen (siehe Kapitel "Programmierung").
- Die Taste **[START/IMPULS]** drücken. Die LED in der Taste **[START/IMPULS]** leuchtet solange der Rotor dreht.
- Nach Ablauf der Zeit oder bei Abbruch des Zentrifugationslaufes durch Drücken der Taste **[OPEN/STOP]**, erfolgt der Auslauf mit der ausgewählten Bremsstufe. Die Bremsstufe wird angezeigt.

Während des Zentrifugationslaufes werden die Drehzahl des Rotors oder der daraus resultierende RCF-Wert, die Proben-Temperatur (nur bei Zentrifuge mit Kühlung), und die verbleibende Zeit angezeigt.

16.2 Dauerlauf

- Das Symbol ∞ einstellen oder ein Dauerlauf-Programm abrufen (siehe Kapitel "Programmierung").
- Die Taste **(START/IMPULS)** drücken. Die LED in der Taste **(START/IMPULS)** leuchtet solange der Rotor dreht. Die Zeitzählung beginnt bei 00:00.
- Die Taste **(OPEN/STOP)** drücken um den Zentrifugationslauf zu beenden. Der Auslauf erfolgt mit der angewählten Bremsstufe. Die Bremsstufe wird angezeigt.

Während des Zentrifugationslaufes werden die Drehzahl des Rotors oder der daraus resultierende RCF-Wert, die Proben-Temperatur (nur bei Zentrifuge mit Kühlung), und die gelaufene Zeit angezeigt.

16.3 Kurzzeitzentrifugation

- Die Taste **(START/IMPULS)** gedrückt halten. Die LED in der Taste **(START/IMPULS)** leuchtet solange der Rotor dreht. Die Zeitzählung beginnt bei 00:00.
- Die Taste **(START/IMPULS)** wieder loslassen um den Zentrifugationslauf zu beenden. Der Auslauf erfolgt mit der angewählten Bremsstufe. Die Bremsstufe wird angezeigt.

Während des Zentrifugationslaufes werden die Drehzahl des Rotors oder der daraus resultierende RCF-Wert, die Proben-Temperatur (nur bei Zentrifuge mit Kühlung), und die gelaufene Zeit angezeigt.

17 Not-Stop

- Die Taste **(OPEN/STOP)** 2x drücken.

Beim Not-Stop erfolgt der Auslauf mit Bremsstufe 9 (kürzeste Auslaufzeit). Die Bremsstufe 9 wird angezeigt. War die Bremsstufe 0 vorgewählt, so ist die Auslaufzeit technisch bedingt länger als mit Bremsstufe 9.

18 Akustisches Signal

Das akustische Signal ertönt:

- bei Auftreten einer Störung im 2 s-Intervall.
- nach Beendigung des Zentrifugationslaufes und Stillstand des Rotors im 30 s-Intervall.

Durch Öffnen des Deckels oder Drücken einer beliebigen Taste wird das akustische Signal beendet.

Das Signal nach Beendigung des Zentrifugationslaufes kann, bei Stillstand des Rotors, folgendermaßen aktiviert oder deaktiviert werden:

- Die Taste **(SELECT)** 8 s gedrückt halten.
Nach 8 s erscheint **SOUND / BELL** in der Anzeige.
- Mit dem Drehknopf **(OFF/ON)** **OFF** (aus) oder **ON** (ein) einstellen.
- Die Taste **(START/IMPULS)** drücken um die Einstellung zu speichern.
Als Bestätigung wird kurzzeitig ***** ok ***** angezeigt.

19 Betriebsstunden-Abfrage

Die Abfrage der Betriebsstunden ist nur bei Stillstand des Rotors möglich.

- Die Taste **(SELECT)** 8 s gedrückt halten.
Nach 8 s erscheint **SOUND / BELL** in der Anzeige.
- Die Taste **(SELECT)** nochmals drücken.
Die Betriebsstunden (**CONTROL:**) der Zentrifuge werden angezeigt.
- Zum Verlassen der Betriebsstunden-Abfrage die Taste **(OPEN/STOP)** drücken.

20 Kühlung (nur bei Zentrifuge mit Kühlung)

Der Temperatur-Sollwert kann von -20°C bis +40°C eingestellt werden. Die tiefste erreichbare Temperatur ist rotorabhängig (siehe Kapitel "Anhang/Appendix, Rotoren und Zubehör/Rotors and accessories").

20.1 Standby-Kühlung

Bei Stillstand des Rotors und geschlossenem Deckel wird der Schleuderraum auf die vorgewählte Temperatur gekühlt. Im Display wird der Temperatur-Sollwert angezeigt.

Nach einem Zentrifugationslauf erfolgt die Standby-Kühlung zeitverzögert, und im Display wird **OPEN** / **OEFFNEN** angezeigt. Die Verzögerungszeit ist von 1 bis 5 Minuten, in 1 Minuten-Schritten einstellbar. Sie ist auf 1 Minute voreingestellt.

Die Verzögerungszeit kann, bei Stillstand des Rotors und geöffnetem Deckel, folgendermaßen eingestellt werden:

- Die Taste ⓧ 8 Sekunden gedrückt halten.
Nach 8 Sekunden erscheint **t/min = X** in der Anzeige.
- Mit dem Drehknopf ⦿ die Verzögerungszeit einstellen.
- Die Taste Ⓢ/IMPULS drücken, um die Einstellung zu speichern.
Als Bestätigung wird kurzzeitig ***** ok ***** angezeigt.

Zum Verlassen der Verzögerungszeit-Anzeige die Taste Ⓢ/STOP drücken oder 8 Sekunden lang keine Taste drücken.

20.2 Vorkühlen des Rotors

- Die Taste ⓧ drücken. Die LED in der Taste Ⓢ/IMPULS leuchtet solange der Rotor dreht.
- Die Taste Ⓢ/STOP drücken um die Vorkühlung zu beenden. Der Auslauf erfolgt mit der angewählten Bremsstufe. Die Bremsstufe wird angezeigt.

Während des Zentrifugationslaufes werden die Drehzahl des Rotors oder der daraus resultierende RCF-Wert, die Proben-Temperatur, und die gelaufene Zeit angezeigt.

Die Vorkühl-Drehzahl ist von 500 RPM bis zur maximalen Drehzahl der Rotors, in 10er Schritten einstellbar. Sie ist voreingestellt auf 2800 RPM.

Die Vorkühl-Drehzahl kann, bei Stillstand des Rotors und geöffnetem Deckel, folgendermaßen eingestellt werden:

- Die Taste ⓧ 8 Sekunden gedrückt halten.
Nach 8 Sekunden erscheint **t/min = X** in der Anzeige.
- Die Taste ⓧ nochmals drücken.
Die eingestellte Vorkühl-Drehzahl **RPM = XXXX** wird angezeigt.
- Mit dem Drehknopf ⦿ die gewünschte Vorkühl-Drehzahl einstellen.
- Die Taste Ⓢ/IMPULS drücken, um die Einstellung zu speichern.
Als Bestätigung wird kurzzeitig ***** ok ***** angezeigt.

Zum Verlassen der Vorkühl-Drehzahl-Anzeige die Taste Ⓢ/STOP drücken oder 8 Sekunden lang keine Taste drücken.

21 Relative Zentrifugalbeschleunigung (RCF)

Die relative Zentrifugalbeschleunigung (RCF) wird als Vielfaches der Erdbeschleunigung (g) angegeben. Sie ist ein einheitsfreier Zahlenwert und dient zum Vergleich der Trenn- und Sedimentationsleistung.

Die Berechnung erfolgt nach der Formel:

$$\text{RCF} = \left(\frac{\text{RPM}}{1000} \right)^2 \times r \times 1,118 \quad \Rightarrow \quad \text{RPM} = \sqrt{\frac{\text{RCF}}{r \times 1,118}} \times 1000$$

RCF = Relative Zentrifugalbeschleunigung

RPM = Drehzahl

r = Zentrifugerradius in mm = Abstand von der Mitte der Drehachse bis zum Zentrifugiergefäßboden.
Zentrifugerradius siehe Kapitel "Anhang/Appendix, Rotoren und Zubehör/Rotors and accessories".



Die relative Zentrifugalbeschleunigung (RCF) ist von der Drehzahl und dem Zentrifugerradius abhängig.

22 Zentrifugation von Stoffen oder Stoffgemischen mit einer höheren Dichte als 1,2 kg/dm³

Bei der Zentrifugation mit maximaler Drehzahl darf die Dichte der Stoffe oder Stoffgemische 1,2 kg/dm³ nicht überschreiten.

Bei Stoffen oder Stoffgemischen mit einer höheren Dichte muss die Drehzahl reduziert werden.

Die erlaubte Drehzahl lässt sich nach folgender Formel berechnen:

$$\text{Reduzierte Drehzahl (n}_{\text{red}}) = \sqrt{\frac{1,2}{\text{höhere Dichte [kg/dm}^3]}} \times \text{maximale Drehzahl [RPM]}$$

z.B.: Maximale Drehzahl 4000 RPM, Dichte 1,6 kg/dm³

$$n_{\text{red}} = \sqrt{\frac{1,2 \text{ kg/dm}^3}{1,6 \text{ kg/dm}^3}} \times 4000 \text{ RPM} = 3464 \text{ RPM}$$

Wird im Ausnahmefall die, auf dem Gehänge angegebene, maximale Beladung überschritten, muss die Drehzahl ebenfalls reduziert werden.

Die erlaubte Drehzahl lässt sich nach folgender Formel berechnen:

$$\text{Reduzierte Drehzahl (n}_{\text{red}}) = \sqrt{\frac{\text{maximale Beladung [g]}}{\text{tatsächliche Beladung [g]}}} \times \text{maximale Drehzahl [RPM]}$$

z.B.: Maximale Drehzahl 4000 RPM, maximale Beladung 300 g, tatsächliche Beladung 350 g

$$n_{\text{red}} = \sqrt{\frac{300 \text{ g}}{350 \text{ g}}} \times 4000 \text{ RPM} = 3703 \text{ RPM}$$

Bei eventuellen Unklarheiten ist Auskunft beim Hersteller einzuholen.

23 Rotorerkennung

Nach Start eines jeden Zentrifugationslaufes wird eine Rotorerkennung durchgeführt.

Wurde der Rotor gewechselt, wird der Zentrifugationslauf nach der Rotorerkennung abgebrochen. Der Rotorcode (rot xx) des Rotors wird angezeigt. Der Rotorcode (R xx) sowie die maximale Drehzahl (n-max=xxxxx) des Rotors werden angezeigt.



Eine weitere Bedienung der Zentrifuge ist erst nach einmaligem Öffnen des Deckels möglich.

Wenn die maximale Drehzahl des verwendeten Rotors kleiner als die eingestellte Drehzahl ist, wird die Drehzahl auf die maximale Drehzahl des Rotors begrenzt.

24 Notentriegelung

Bei einem Stromausfall kann der Deckel nicht motorisch entriegelt werden. Es muss eine Notentriegelung von Hand durchgeführt werden.



Zur Notentriegelung die Zentrifuge vom Netz trennen.
Den Deckel nur bei Stillstand des Rotors öffnen.

Siehe Abbildung auf Seite 2.

- Den Netzschalter ausschalten (Schalterstellung "0").
- Durch das Fenster im Deckel schauen, um sich zu vergewissern, dass der Rotor stillsteht.
- Den Sechskant-Stiftschlüssel waagrecht in die Bohrung (Fig. 1, A) einführen und vorsichtig eine halbe Umdrehung im Uhrzeigersinn drehen, bis sich der Deckel öffnen lässt.
- Den Sechskant-Stiftschlüssel wieder aus der Bohrung herausziehen.
- Wenn nach dem Wiedereinschalten der Zentrifuge die linke LED in der Taste **OPEN/STOP** blinkt, die Taste **OPEN/STOP** drücken, dass die motorische Deckelverriegelung wieder die Grundstellung (geöffnet) einnimmt.

25 Pflege und Wartung



Das Gerät kann kontaminiert sein.



Vor der Reinigung den Netzstecker ziehen.

Bevor ein anderes als das vom Hersteller empfohlene Reinigungs- oder Dekontaminationsverfahren angewandt wird, hat sich der Benutzer beim Hersteller zu vergewissern, dass das vorgesehene Verfahren das Gerät nicht schädigt.

- Zentrifugen, Rotoren und das Zubehör dürfen nicht in Spülmaschinen gereinigt werden.
- Es darf nur eine Handreinigung und eine Flüssig-Desinfektion durchgeführt werden.
- Die Wassertemperatur muss 20 – 25°C betragen.
- Es dürfen nur Reinigungs- oder Desinfektionsmittel verwendet werden, die:
 - im pH-Bereich 5 - 8 liegen,
 - keine Ätzalkalien, Peroxide, Chlorverbindungen, Säuren und Laugen enthalten.
- Um Korrosionserscheinungen durch Reinigungs- oder Desinfektionsmittel zu vermeiden sind die speziellen Anwendungshinweise vom Hersteller des Reinigungs- oder Desinfektionsmittels unbedingt zu beachten.

25.1 Zentrifuge (Gehäuse, Deckel und Schleuderraum)

25.1.1 Oberflächenreinigung und -pflege

- Das Gehäuse der Zentrifuge und den Schleuderraum regelmäßig säubern und bei Bedarf mit Seife oder einem milden Reinigungsmittel und einem feuchten Tuch reinigen. Dies dient zum einen der Hygiene und es verhindert Korrosion durch anhaftende Verunreinigungen.
- Inhaltsstoffe geeigneter Reinigungsmittel:
Seife, anionische Tenside, nichtionische Tenside.
- Nach dem Einsatz von Reinigungsmitteln, die Reste des Reinigungsmittels, durch Nachwischen mit einem feuchten Tuch, entfernen.
- Die Flächen müssen unmittelbar nach der Reinigung getrocknet werden.
- Bei Bildung von Kondenswasser den Schleuderraum, durch Auswischen mit einem saugfähigen Tuch, trocknen.
- Die Gummidichtung des Schleuderraums nach jeder Reinigung mit Talkum-Puder oder einem Gummi-Pflegemittel leicht einreiben.
- Der Schleuderraum ist jährlich auf Schäden zu überprüfen.



Werden sicherheitsrelevante Schäden festgestellt, darf die Zentrifuge nicht mehr in Betrieb genommen werden. In diesem Fall ist der Kundendienst zu benachrichtigen.

25.1.2 Oberflächendesinfektion

- Gelangt infektiöses Material in den Schleuderraum, so ist dieser umgehend zu desinfizieren.
- Inhaltsstoffe geeigneter Desinfektionsmittel:
Äthanol, n-Propanol, Isopropanol, Glutardialdehyd, quaternäre Ammoniumverbindungen.
- Nach dem Einsatz von Desinfektionsmitteln, die Reste des Desinfektionsmittels, durch Nachwischen mit einem feuchten Tuch, entfernen.
- Die Flächen müssen unmittelbar nach der Desinfektion getrocknet werden.

25.1.3 Entfernen radioaktiver Verunreinigungen

- Das Mittel muss speziell für das Entfernen radioaktiver Verunreinigungen ausgewiesen sein.
- Inhaltsstoffe geeigneter Mittel für das Entfernen radioaktiver Verunreinigungen:
Anionische Tenside, nichtionische Tenside, polyhydrierter Äthanol.
- Nach dem Entfernen der radioaktiven Verunreinigungen, die Reste des Mittels, durch Nachwischen mit einem feuchten Tuch, entfernen.
- Die Flächen müssen unmittelbar nach dem Entfernen der radioaktiven Verunreinigungen getrocknet werden.

25.2 Rotoren und Zubehör

25.2.1 Reinigung und Pflege

- Um einer Korrosion und Materialveränderungen vorzubeugen müssen die Rotoren und das Zubehör regelmäßig mit Seife oder einem milden Reinigungsmittel und einem feuchten Tuch gereinigt werden. Die Reinigung wird mindestens einmal wöchentlich empfohlen. Verschmutzungen müssen sofort entfernt werden.
- Inhaltsstoffe geeigneter Reinigungsmittel:
Seife, anionische Tenside, nichtionische Tenside.
- Nach dem Einsatz von Reinigungsmitteln, die Reste des Reinigungsmittels, durch Nachspülen mit Wasser (nur außerhalb der Zentrifuge) oder Nachwischen mit einem feuchten Tuch, entfernen.
- Die Rotoren und das Zubehör müssen unmittelbar nach der Reinigung getrocknet werden.
- Winkelrotoren, Behälter und Gehänge aus Aluminium sind nach dem Trocknen mit säurefreiem Fett z.B. Vaseline leicht einzufetten.
- Bei Bio-Sicherheitssystemen (lieferbare Bio-Sicherheitssysteme siehe Kapitel "Anhang/Appendix, Rotoren und Zubehör/Rotors and accessories") sind die Dichtungsringe regelmäßig (wöchentlich) zu prüfen und zu reinigen. Bei Anzeichen von Rissbildung, Versprödung oder Abnutzung ist der Dichtungsring sofort auszutauschen. Um ein Verdrehen des Dichtungsringes während dem Öffnen und Schließen des Deckels zu vermeiden, muss der Dichtungsring mit Talkum-Puder oder einem Gummi-Pflegemittel leicht eingerieben werden.
- Um Korrosion infolge Feuchtigkeit zwischen Rotor und Motorwelle zu verhindern, sollte der Rotor mindestens einmal im Monat ausgebaut, gereinigt und die Motorwelle leicht gefettet werden.
- Die Rotoren und das Zubehör sind monatlich auf Verschleiß und Korrosionsschäden zu überprüfen. Bei Ausschwingrotoren muss vor allem der Bereich der Tragzapfen und bei Gehängen die Nuten und der Boden auf Risse geprüft werden.



Rotoren und Zubehör dürfen bei Anzeichen von Verschleiß oder Korrosion nicht mehr verwendet werden.

- Den Rotor wöchentlich auf festen Sitz prüfen.

25.2.2 Desinfektion

- Gelangt infektiöses Material auf die Rotoren oder auf das Zubehör, so muss eine geeignete Desinfektion durchgeführt werden.
- Inhaltsstoffe geeigneter Desinfektionsmittel:
Glutaraldehyd, Propanol, Ethylhexanol, anionische Tenside, Korrosionsinhibitoren.
- Nach dem Einsatz von Desinfektionsmitteln, die Reste des Desinfektionsmittels, durch Nachspülen mit Wasser (nur außerhalb der Zentrifuge) oder Nachwischen mit einem feuchten Tuch, entfernen.
- Die Rotoren und das Zubehör müssen unmittelbar nach der Desinfektion getrocknet werden.

25.2.3 Entfernen radioaktiver Verunreinigungen

- Das Mittel muss speziell für das Entfernen radioaktiver Verunreinigungen ausgewiesen sein.
- Inhaltsstoffe geeigneter Mittel für das Entfernen radioaktiver Verunreinigungen:
Anionische Tenside, nichtionische Tenside, polyhydrierter Äthanol.
- Nach dem Entfernen der radioaktiven Verunreinigungen, die Reste des Mittels, durch Nachspülen mit Wasser (nur außerhalb der Zentrifuge) oder Nachwischen mit einem feuchten Tuch, entfernen.
- Die Rotoren und das Zubehör müssen unmittelbar nach dem Entfernen der radioaktiven Verunreinigungen getrocknet werden.

25.2.4 Tragzapfen

Bei Ausschwingrotoren müssen die Tragzapfen regelmäßig gefettet werden (Hettich-Schmierfett Nr. 4051), um ein gleichmäßiges Ausschwingen der Gehänge zu gewährleisten.

25.2.5 Rotoren und Zubehör mit begrenzter Verwendungsdauer

Die Verwendung von bestimmten Rotoren, Gehängen und Zubehörteilen ist zeitlich begrenzt.

Diese sind mit der maximal erlaubten Anzahl der Lauf-Zyklen oder dem Ablaufdatum und der maximalen Anzahl der Lauf-Zyklen oder nur mit dem Ablaufdatum gekennzeichnet, z.B.:

- "einsetzbar bis Ende: IV. Quartal 2011 / usable until end of: IV. Quartal 2011" oder
"einsetzbar bis Ende Monat/Jahr: 10/2011 / usable until end of month/year: 10/2011"
- "max. Laufzyklen / max. cycles: 40000".



Aus Sicherheitsgründen dürfen die Rotoren, Gehänge und Zubehörteile nicht mehr verwendet werden, wenn entweder die darauf gekennzeichnete maximal erlaubte Anzahl der Lauf-Zyklen oder das darauf gekennzeichnete Ablaufdatum erreicht ist.

25.3 Autoklavieren

Das folgende Zubehör darf bei 121°C / 250°F (20 min) autoklaviert werden:

- Ausschwingrotoren
- Winkelrotoren aus Aluminium
- Gehänge aus Metall
- Deckel mit Bioabdichtung
- Gestelle
- Reduzierungen

Im Zweifelsfall muss beim Hersteller nachgefragt werden.

Über den Sterilitätsgrad kann keine Aussage gemacht werden.



Die Deckel der Rotoren und Behälter müssen vor dem Autoklavieren abgenommen werden.
Das Autoklavieren beschleunigt den Alterungsprozess von Kunststoffen. Außerdem kann es bei Kunststoffen Farbveränderungen verursachen.
Wir empfehlen nach dem Autoklavieren die Dichtungsringe von Bio-Sicherheitssystemen auszutauschen.

25.4 Zentrifugiergefäße

- Bei Undichtigkeit oder nach dem Bruch von Zentrifugiergefäßen, sind zerbrochene Gefäßteile, Glassplitter und ausgelaufenes Zentrifugiergut vollständig zu entfernen.
- Die Gummieinlagen sowie die Kunststoff-Hülsen der Rotoren sind nach einem Glasbruch zu ersetzen.



Verbleibende Glassplitter verursachen weiteren Glasbruch !

- Handelt es sich um infektiöses Material so ist umgehend eine Desinfektion durchzuführen.

26 Störungen

Lässt sich der Fehler laut Störungstabelle nicht beheben, so ist der Kundendienst zu benachrichtigen.

Bitte den Zentrifugentyp und die Seriennummer angeben. Beide Nummern sind auf dem Typenschild der Zentrifuge ersichtlich.



Einen NETZ-RESET durchführen:

- Den Netzschalter ausschalten (Schalterstellung "0").
- Mindestens 10 Sekunden lang warten und anschließend den Netzschalter wieder einschalten (Schalterstellung "I").

Anzeige		Ursache	Beseitigung
keine Anzeige	---	keine Spannung. Auslösen der Überstromsichersicherung.	- Versorgungsspannung überprüfen. - Netzschalter EIN.
TACHO - ERROR	1, 2, 96	Tacho defekt. Motor, Elektronik defekt.	- Deckel öffnen. - Den Netzschalter ausschalten (Schalterstellung "0"). - Mindestens 10 Sekunden lang warten. - Den Rotor von Hand kräftig drehen. - Den Netzschalter wieder einschalten (Schalterstellung "I"). Während des Einschaltens muss sich der Rotor drehen
CONTROL - ERROR	8	Fehler Deckelverriegelung	
IMBALANCE	---	Der Rotor ist ungleichmäßig beladen.	- Deckel öffnen. - Die Beladung des Rotors überprüfen, siehe Kapitel "Beladen des Rotors". - Den Zentrifugationslauf wiederholen.
CONTROL - ERROR	4, 6	Fehler Deckelverriegelung	- Einen NETZ-RESET durchführen.
N > MAX	5	Überdrehzahl	
N < MIN	13	Unterdrehzahl	
MAINS INTERRUPT	---	Netzunterbrechung während des Zentrifugationslaufes. (Der Zentrifugationslauf wurde nicht beendet.)	- Deckel öffnen. - Taste START / IMPULS drücken. - Bei Bedarf den Zentrifugationslauf wiederholen.
ROTORCODE	10.1, 10.2	Fehler Rotorcodierung	- Deckel öffnen.
CONTROL-ERROR	21, 22, 25, 27, 29	Fehler / Defekt Elektronik	- Einen NETZ-RESET durchführen.
CONTROL-ERROR	23	Fehler / Defekt Bedienteil	
SER I/O - ERROR	30, 31, 33, 36	Fehler / Defekt Elektronik	
° C * - ERROR	51 - 53, 55	Fehler / Defekt Elektronik	
FU / CCI - ERROR	60 - 64, 67, 68, 82 - 86	Fehler / Defekt Elektronik / Motor	
SYNC-ERROR	90	Fehler / Defekt Elektronik	
SENSOR-ERROR	91 - 93	Fehler / Defekt Unwuchtsensor	
KEYBOARD-ERROR	---	Fehler / Defekt Bedienteil	
NO ROTOR	---	Kein Rotor eingebaut	- Deckel öffnen. - Rotor einbauen.
N > ROTOR MAX	---	Drehzahl im angewählten Programm größer als die maximale Drehzahl des Rotors.	- Drehzahl überprüfen und korrigieren.
		Der Rotor wurde gewechselt. Der eingebaute Rotor hat eine höhere maximale Drehzahl als der vorher verwendete Rotor, und er wurde noch nicht von der Rotorerkennung erkannt.	- Eine Drehzahl, bis zur maximalen Drehzahl des vorher verwendeten Rotors, einstellen. Die Taste START / IMPULS drücken, um eine Rotorerkennung durchzuführen, siehe Kapitel "Rotorerkennung".

27 Rücksendung von Geräten



Vor der Rücksendung des Gerätes muss die Transportsicherung eingebaut werden.

Wird das Gerät oder dessen Zubehör an die Firma Andreas Hettich GmbH & Co. KG zurückgesandt, so muss dieses, zum Schutz von Personen, Umwelt und Material, vor dem Versand dekontaminiert und gereinigt werden.

Eine Annahme von kontaminierten Geräten oder Zubehör behalten wir uns vor.

Anfallende Kosten für Reinigungs- und Desinfektionsmaßnahmen werden dem Kunden in Rechnung gestellt.

Wir bitten dafür um Ihr Verständnis.

28 Entsorgung

Vor der Entsorgung muss das Gerät, zum Schutz von Personen, Umwelt und Material, dekontaminiert und gereinigt werden.

Bei der Entsorgung des Geräts sind die jeweiligen gesetzlichen Vorschriften zu beachten.

Gemäß der Richtlinie 2002/96/EG (WEEE) dürfen alle nach dem 13.08.2005 gelieferten Geräte nicht mehr mit dem Hausmüll entsorgt werden. Das Gerät gehört zur Gruppe 8 (Medizinische Geräte) und ist in den Business-to-Business-Bereich eingeordnet.



Mit dem Symbol des durchgestrichenen Abfalleimers wird darauf hingewiesen, dass das Gerät nicht mit dem Hausmüll entsorgt werden darf.

Die Entsorgungsvorschriften der einzelnen EU-Länder können unterschiedlich sein. Im Bedarfsfall wenden Sie sich bitte an Ihren Lieferanten.

Contents

1	Use according to specification	32
2	Remaining risks	32
3	Technical specifications	32
4	Notes on safety	35
5	Symbol meanings	37
6	Delivery checklist	37
7	Unpacking the centrifuge	37
8	Initial operation	38
9	Opening and closing the lid	38
9.1	Opening the lid	38
9.2	Closing the lid	38
10	Installation and removal of the rotor	39
11	Loading the rotor	39
12	Closing biosafety systems	40
13	Control and display elements	40
13.1	Control knob	40
13.2	Control panel pushbuttons (keys)	40
13.3	Adjustment possibilities	41
14	Entering centrifugation parameter	41
15	Programming	42
15.1	Programme input/alteration	42
15.2	Programme recall	42
16	Centrifugation	42
16.1	Centrifugation with pre-set time	42
16.2	Continuous run	43
16.3	Short-term centrifugation	43
17	Emergency Stop	43
18	Acoustic Signal	43
19	Recall hours of operation	43
20	Cooling (only in centrifuges with cooling)	44
20.1	Standby-cooling	44
20.2	Pre-cooling the rotor	44
21	Relative centrifugal force (RCF)	44
22	Centrifugation of materials or mixtures of materials with a density higher than 1.2 kg/dm ³	45
23	Rotor recognition	45
24	Emergency release	45
25	Maintenance and servicing	46
25.1	Centrifuge (housing, lid and centrifuging chamber)	46
25.1.1	Surface cleaning and care	46
25.1.2	Surface disinfection	46
25.1.3	Removal of radioactive contaminants	46

25.2	Rotors and Attachments.....	47
25.2.1	Cleaning and care.....	47
25.2.2	Disinfection	47
25.2.3	Removal of radioactive contaminants	47
25.2.4	Trunnions.....	47
25.2.5	Rotors and accessories with limited service lives	47
25.3	Autoclaving	48
25.4	Centrifuge containers.....	48
26	Faults	49
27	Returning Devices	50
28	Disposal	50
29	Anhang / Appendix.....	93
29.1	Rotoren und Zubehör / Rotors and accessories.....	93

1 Use according to specification

This device is a medical product (laboratory centrifuge) within the context of the IVD Directive 98/79/EC.

The centrifuge was designed only for the separation of materials or mixtures with a density of no more than 1.2 kg/dm³. In particular, these include samples for preparation of in-vitro diagnostic purposes in human medicine.

The centrifuge is only meant for this purpose.

Another use or one which goes beyond this, is considered to be non-intended. The company Andreas Hettich GmbH & Co. KG is not liable for damage resulting from this.

Observing all information in the operating instructions and complying with the measures described therein is also a part of the intended use.

2 Remaining risks

The device is built according to the state-of-the-art and the recognized safety regulations. If used and handled improperly, there could be life-threatening danger to the user or third parties, or the device could be impaired or there could be other property damage. The device is only to be used for its intended purpose and only when it is in safe working condition.

Malfunctions which could affect safety must be corrected immediately.

3 Technical specifications

Manufacturer	Andreas Hettich GmbH & Co. KG D-78532 Tuttlingen				
Model	UNIVERSAL 320		UNIVERSAL 320 R		
Type	1401	1401-01	1406	1406-01	
Mains voltage (± 10%)	200-240 V 1~	100-127 V 1~	200-240 V 1~	240 V 1~	115-127 V 1~
Mains frequency	50 – 60 Hz	50 – 60 Hz	50 Hz	60 Hz	60 Hz
Connected load	400 VA	400 VA	800 VA		950 VA
Current consumption	2.0 A	4.0 A	4.0 A		8.0 A
Cooling medium	----		R 404A		
Max. capacity	4 x 100 ml				
Allowed density	1.2 kg/dm ³				
Speed (RPM)	15000				
Force (RCF)	21382				
Kinetic energy	8600 Nm				
Obligatory inspection (BGR 500)	no				
Ambient conditions (EN / IEC 61010-1)	Indoors only				
– Set-up site	Up to 2000 m above sea level				
– Altitude					
– Ambient temperature	2°C to 35°C		5°C to 35°C		
– Humidity	Maximum relative humidity 80% for temperatures up to 31°C, linearly decreasing to 50% relative humidity at 40°C.				
– Excess-voltage category (IEC 60364-4-443)	II				
– Pollution degree	2				
Device protection class	I				
Not suitable for use in explosion-endangered areas.					
EMC	EN / IEC 61326-1, Class B		FCC Class B		EN / IEC 61326-1, Class B FCC Class B
– Emitted interference, Interference immunity	EN / IEC 61326-1, Class B		FCC Class B		EN / IEC 61326-1, Class B FCC Class B
Noise level (dependent on rotor)	≤ 68 dB(A)		≤ 58 dB(A)		
Dimensions					
– Width	395 mm		401 mm		
– Depth	520 mm		695 mm		
– Height	346 mm		346 mm		
Weight	approx. 31 kg		approx. 53 kg		approx. 52 kg

Manufacturer	Andreas Hettich GmbH & Co. KG D-78532 Tuttlingen			
Model	UNIVERSAL 320 R			
Type	1406-50	1406-51	1406-70	1406-71
Mains voltage ($\pm 10\%$)	200-240 V 1~	100-127 V 1~	200-240 V 1~	100-127 V 1~
Mains frequency	50 – 60 Hz	50 – 60 Hz	50 – 60 Hz	50 – 60 Hz
Connected load	400 VA	400 VA	400 VA	400 VA
Current consumption	2.0 A	4.0 A	2.0 A	4.0 A
Max. capacity	4 x 100 ml			
Allowed density	1.2 kg/dm ³			
Speed (RPM)	15000			
Force (RCF)	21382			
Kinetic energy	8600 Nm			
Obligatory inspection (BGR 500)	no			
Ambient conditions (EN / IEC 61010-1)	Indoors only Up to 2000 m above sea level 2°C to 35°C Maximum relative humidity 80% for temperatures up to 31°C, linearly decreasing to 50% relative humidity at 40°C.			
– Set-up site				
– Altitude				
– Ambient temperature				
– Humidity				
– Excess-voltage category (IEC 60364-4-443)	II			
– Pollution degree	2			
Device protection class	I			
Not suitable for use in explosion-endangered areas.				
EMC				
– Emitted interference, Interference immunity	EN / IEC 61326-1, Class B	FCC Class B	EN / IEC 61326-1, Class B	FCC Class B
Noise level (dependent on rotor)	≤ 58 dB(A)			
Dimensions				
– Width	395 mm			
– Depth	520 mm			
– Height	346 mm			
Weight	approx. 35 kg			

Manufacturer	Andreas Hettich GmbH & Co. KG D-78532 Tuttlingen		
Model	UNIVERSAL 320 R		
Type	1406-20		1406-21
Mains voltage (± 10%)	200-240 V 1~	240 V 1~	115-127 V 1~
Mains frequency	50 Hz	60 Hz	60 Hz
Connected load	800 VA		950VA
Current consumption	4.0 A		8.0 A
Cooling medium	R 404A		
Max. capacity	4 x 100 ml		
Allowed density	1.2 kg/dm ³		
Speed (RPM)	15000		
Force (RCF)	21382		
Kinetic energy	8600 Nm		
Obligatory inspection (BGR 500)	no		
Ambient conditions (EN / IEC 61010-1)	<p>Indoors only</p> <p>Up to 2000 m above sea level</p> <p>5°C to 35°C</p> <p>Maximum relative humidity 80% for temperatures up to 31°C, linearly decreasing to 50% relative humidity at 40°C.</p>		
– Set-up site			
– Altitude			
– Ambient temperature			
– Humidity			
– Excess-voltage category (IEC 60364-4-443)	II		
– Pollution degree	2		
Device protection class	I		
Not suitable for use in explosion-endangered areas.			
EMC			
– Emitted interference, Interference immunity	EN / IEC 61326-1, Class B	FCC Class B	
Noise level (dependent on rotor)	≤ 58 dB(A)		
Dimensions			
– Width	401 mm		
– Depth	695 mm		
– Height	346 mm		
Weight	approx. 52 kg		

4 Notes on safety



No claim of warranty will be considered by the manufacturer unless ALL instructions in this manual have been followed.



- **The centrifuge should be installed on a good, stable base.**
- **Before using the centrifuge absolutely check the rotor for firm placement.**
- **When the centrifuge is running, according to EN / IEC 61010-2-020, no persons, dangerous substances or objects may be within the safety margin of 300 mm around the centrifuge.**
- **Rotors, suspensions and accessories that possess traces of corrosion or mechanical damage or if their term of use has expired may not be used any longer.**
- **The centrifuge may no longer be put into operation when the centrifuging chamber has safety-related damages.**
- **With swing-out rotors the trunnions must be regularly lubricated (Hettich Lubricating Grease No. 4051) in order to ensure consistent swinging out of the hangers.**
- **For centrifuges without temperature control, when the room temperature is increased and/or if the device is frequently used, the centrifuging chamber could be heated up. Therefore, it can't be ruled out that the sample material might be changed due to the temperature.**

- **Before the initial operation of your centrifuge you should read and pay attention to the operating instructions. Only personnel that has read and understood the operating instructions are allowed to operate the device.**
- Along with the operating instructions and the legal regulations on accident prevention, you should also follow the recognised professional regulations for working in a safe and professional manner. These operating instructions should be read in conjunction with any other instructions concerning accident prevention and environmental protection based on the national regulations of the country where the device is to be used.
- This centrifuge is a state-of-the-art piece of equipment which is extremely safe to operate. However, it can lead to danger for users or others if used by untrained staff, in an inappropriate way or for a purpose other than that it was designed for.
- The centrifuge must not be moved or knocked during operation.
- In case of fault or emergency release, never touch the rotor before it has stopped turning.
- To avoid damage due to condensate, when changing from a cold to a warm room the centrifuge must either heat up for at least 3 hours in the warm room before being connected to the mains, or run hot for 30 minutes in the cold room.
- Only the rotors and accessories approved by the manufacturer for this device may be used (see chapter "Anhang/Appendix, Rotoren und Zubehör/Rotors and accessories"). Before centrifuge vessels are used which are not listed in the chapter "Appendix, Rotors and accessories", the user must make sure they can be used by asking the manufacturer.
- The centrifuge rotor may only be loaded in accordance with the chapter "Loading the rotor".
- When centrifuging with maxim revolutions per minute the density of the materials or the material mixtures may not exceed 1.2 kg/dm³.
- The centrifuge may only be operated when the balance is within the bounds of acceptability.
- The centrifuge may not be operated in explosion-endangered areas.
- The centrifuge must not be used with:
 - inflammable or explosive materials
 - materials that react with one another producing a lot of energy.
- If users have to centrifuge hazardous materials or compounds contaminated with toxic, radioactive or pathogenic micro-organisms, they must take appropriate measures.
For hazardous substances centrifuge containers with special screw caps must strictly be used. In addition to the screw cap centrifuge containers, for materials in hazard category 3 and 4 a biosafety system must be used (see the World Health Organisation's "Laboratory Biosafety Manual").
In a biosafety system, droplets and aerosols are prevented from escaping by a bioseal (packing ring).

If the hanger of a biosafety system is used without the lid, the packing ring must be removed from the hanger in order to prevent the packing ring from being damaged during the centrifugation run. Damaged packing rings must not be used to seal the biosafety system.

Without the use of a biosafety system the centrifuge is not microbiologically sealed in the sense of the EN / IEC 610101-2-020 standard.

When closing a biosafety system, please observe the instructions provided in the chapter, "Closing Biosafety Systems".

For further details of available biosafety systems see chapter "Anhang/Appendix, Rotoren und Zubehör/Rotors and accessories". If in doubt, you should obtain relevant information from the manufacturer.

- The centrifuge must not be operated with highly corrosive substances which could impair the mechanical integrity of rotors, hangers and accessories.
- Repairs must only be carried out by personnel authorised to do so by the manufacturer.
- Only original spare parts and original accessories licensed by the Andreas Hettich GmbH & Co. KG company are allowed to be utilised.
- The following safety regulations apply:
EN / IEC 61010-1 and EN / IEC 61010-2-020 as well as their national deviations.
- The safe operation and reliability of the centrifuge can only be guaranteed if:
 - the centrifuge is operated in accordance with the operating instructions,
 - the electrical installation on the site where the centrifuge is installed conforms to the demands of EN / IEC stipulations,
 - prescribed tests to BGV A1, BGR 500 are carried out by an expert.

5 Symbol meanings



Symbol on the device:
Attention, general hazard area.
Before using the device, make sure you read the operating instructions and observe the safety information!



Symbol in this document:
Attention, general hazard area.
This symbol refers to safety relevant warnings and indicates possibly dangerous situations.
The non-adherence to these warnings can lead to material damage and injury to personal.



Symbol on the device and in this document:
Beware of biohazard.



Symbol in this document:
This symbol refers to important circumstances.



Symbol on the device and in this document:
Symbol for the separate collection of electric and electronic devices according to the guideline 2002/96/EG (WEEE). The device belongs to Group 8 (medical devices).



Applies in the countries of the European Union, as well as in Norway and Switzerland.

6 Delivery checklist

- 1 Connecting cable
- 1 Hexagonal pin-type spanner
- 1 Lubricating grease for trunnions
- 1 Operating instructions
- 1 Notes on moving the equipment safely

The rotor(s) and associated accessories are included in the delivery in the quantity ordered.

7 Unpacking the centrifuge

- Lift the carton upward and remove the padding.

- | | |
|---|---|
|  | Do not lift by the front panel.
Observe the weight of the centrifuge, refer to chapter "Technical specifications". |
|---|---|

Lift the centrifuge on both sides with an appropriate number of helpers and place it on the laboratory table.

8 Initial operation

- According to the laboratory instrument standards EN / IEC 61010-2-020 an emergency switch to separate power supply in the event of a failure must be installed in the building electrical system.
This switch has to be placed remote from the centrifuge, preferred outside of the room in which the centrifuge is installed or near by the exit of this room.
- Remove the transportation safety device from the bottom of the housing, see sheet "Transportation safety device"
- **Position the centrifuge in a stable and level manner in a suitable place. During set-up, the required safety margin of 300 mm around the centrifuge is to be kept according to EN / IEC 61010-2-020.**



When the centrifuge is running, according to EN / IEC 61010-2-020, no persons, dangerous substances or objects may be within the safety margin of 300 mm around the centrifuge.

- Do not place any object in front of the ventiduct.
Keep a ventilation area of 300 mm around the ventiduct.
- In the case of the centrifuge, type 1406-20, 1406-21, connect the nitrogen supply according to the enclosed instruction sheet AH1406-20XX.
In the case of the centrifuge, type 1406-50, 1406-51, connect the refrigerating/heating circulator according to the enclosed instruction sheet AH1406-50XX.
In the case of the centrifuge, type 1406-70, 1406-71, connect the refrigerating/heating circulator and the nitrogen supply according to the enclosed instruction sheet AH1406-70XX.



It is mandatory that the centrifuge be connected according to the enclosed instruction sheet.
Make sure you observe the enclosed instruction sheet.

- Check whether the mains voltage tallies with the statement on the type plate.
- Connect the centrifuge with the connection cable to a standard mains socket. For connection ratings refer to Chapter "Technical specifications".
- Turn on the mains switch. Switch position "I".
The machine type and program version will be displayed and the LEDs light up. After 8 seconds, **⊗ OPEN ⊗ OEFFNEN** is displayed and the left LED on the **⊗ STOP / OPEN ⊗** key blinks.
- Open the lid.
The last used centrifuge data will be displayed.

9 Opening and closing the lid

9.1 Opening the lid



The lid can only be opened when the centrifuge is switched on and the rotor is at rest. If it cannot be opened under these circumstances, see the section on "Emergency release".

- Press the button **⊗ OPEN / STOP ⊗**. The lid unlocks via the motor and the left LED in the pushbutton **⊗ OPEN / STOP ⊗** extinguishes.

9.2 Closing the lid



Do not put your fingers between lid and housing.

Do not bang the lid shut.

If the left LED in the **⊗ OPEN / STOP ⊗** button flashes, press the **⊗ OPEN / STOP ⊗** button so that the motor-driven lid lock goes into the basic position (opened).

- Place the lid and lightly press down the front edge of the lid. The locking action is effected by motor. The left LED in the button **⊗ OPEN / STOP ⊗** lights up.

10 Installation and removal of the rotor

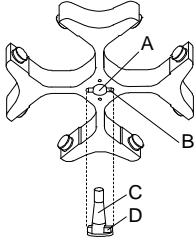

- Clean the motor shaft (C) and the rotor drilling (A), and lightly grease the motor shaft afterwards. Dirt particles between the motor shaft and the rotor hinder a perfect seating of the rotor and cause an irregular operation.
- Place the rotor vertically on the motor shaft. The motor shaft dog (D) has to fit in the rotor slot (B). The alignment of the groove is labelled on the rotor.
- Tighten the rotor tension nut with the supplied wrench by turning in a clockwise direction.
- Check the rotor for firm seating.
- Loosening the rotor: Loosen the tension nut by turning in a counter clockwise direction, and turning until the working point for lifting. After passing the working point for lifting the rotor is loosened from the motor shaft cone. Turn the tension nut until the rotor is able to be lifted from the motor shaft.

11 Loading the rotor



Standard centrifuge containers of glass will not stand RCF values exceeding 4000 (DIN 58970, pg. 2).

- Check the rotor for firm seating.
- With swing-out rotors all rotor positions must be lined with **identical** hangers. Certain hangers are marked with the number of the rotor position. These hangers may only be used in the respective rotor position. Hangers that are marked with a set number (e.g. S001/4) may only be used in the set.
- The rotors and hangers may only be loaded symmetrically. The centrifuge containers have to be distributed evenly on all rotor positions. For authorised combinations see Chapter "Anhang/Appendix, Rotoren und Zubehör/Rotors and accessories".

In the case of angle rotors all possible rotor positions must be loaded, see chapter "Anhang/Appendix, Rotoren und Zubehör/Rotors and accessories".

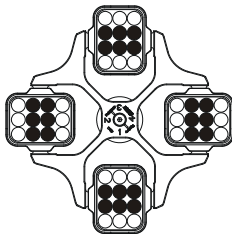

Rotor is evenly loaded

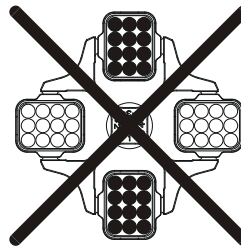

Not permitted!

Rotor is not evenly loaded

- On certain hangers, the weight of the maximum load or the weight of the maximum load and the maximum weight of the completely loaded hanger is specified. This weight may not be exceeded. In case of exception, see chapter "Centrifugation of materials or mixtures of materials with a density higher than 1.2 kg/dm³". The weight specified for the maximum loading includes the total weight of adapter, frame, centrifuging container and content.
- In containers with rubber inserts, the same number of rubber inserts must always be among the centrifuge containers.
- Always fill the centrifuge containers outside of the centrifuge.
- No liquid should be allowed to enter the centrifugal chamber during filling and swinging out of the hangers.
- The maximum filling quantity for the centrifuge containers specified by the manufacturer must not be exceeded.
- In order to maintain the weight differences within the centrifuge container as marginal as possible, a consistent fill level in the containers is to be heeded.

12 Closing biosafety systems



In order to guarantee that it is sealed, the lid to the biosafety system has to be firmly closed.

In order to prevent the packing ring from twisting when opening and closing the cover, the packing ring must be lightly rubbed with talcum powder or a rubber care product.

If the hanger of a biosafety system is used without the lid, the packing ring must be removed from the hanger in order to prevent the packing ring from being damaged during the centrifugation run. Damaged packing rings must not be used to seal the biosafety system.

For further details of available biosafety systems see chapter "Anhang/Appendix, Rotoren und Zubehör/Rotors and accessories". If in doubt, you should obtain relevant information from the manufacturer.

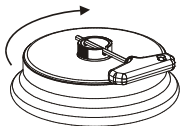

Lid with screw top and hole in turning handle:

- Insert the supplied key into the hole in the handle and close the lid firmly by turning the key in a clockwise direction.

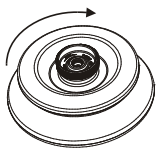

Lid with screw top, without hole in turning handle:

- Close the lid firmly by hand by turning in clockwise direction.

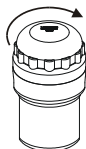

Lid with screw top:

- Close the lid firmly by hand by turning in clockwise direction.

13 Control and display elements

See figure on page 2.

Fig. 2, Fig. 3: Display and control panel

13.1 Control knob



For setting the individual parameters.

Turning anticlockwise reduces the value. Turning clockwise increases the value.

13.2 Control panel pushbuttons (keys)



- Selection control key for selection of specific parameter. The subsequent parameter is selected by every further keystroke.



- Start centrifugation run. The LED in the button lights up during the centrifugation run as long as the rotor is turning.
- Short-term centrifugation. The centrifugation run is effected as long as the button is held down. The LED in the button lights up during the centrifugation run as long as the rotor is turning.
- Store inputs and changes.



- End centrifugation run. The rotor runs down with a pre-selected brake step. The right-hand LED in the button lights up until the rotor is stationary. Once the rotor is stationary the left-hand LED flashes in the button. Pressing the button twice triggers the EMERGENCY STOP.
- Unlock the lid. The left-hand LED in the button goes out.
- Leave the parameter input.



- Switch between RPM and RCF display. RCF values are displayed in > <.



- Start pre-cooling. The pre-cooling speed is settable. It is pre-adjusted to 2800 RPM.

13.3 Adjustment possibilities

PROG RCL Program position of the called-up program.

t/min Running time. Settable from 0 - 99 min, in 1 min increments.

t/sec Running time. Settable from 0 - 59 s, in 1 second increments.

Continuous run "∞". Set parameter **t/min** and **t/sec** to zero.

RPM Revolutions per minute. A numerical value from 500 RPM up to the maximum speed of the rotor can be set. Maximum speed of the rotor, see Chapter "Anhang/Appendix, Rotoren und Zubehör/Rotors and accessories". Settable in increments of 10.

RAD/mm Centrifugation radius. Input in mm. For centrifugation radius see Chapter "Anhang/Appendix, Rotoren und Zubehör/Rotors and accessories". The input of the radius is only possible if the RCF display (> RCF <) is selected.

RCF Relative centrifugal force. A numerical value can be set, which gives a speed between 500 RPM and the maximum speed of the rotor. Adjustable up to 100 in intervals of 1, and from 100 in intervals of 10. The RCF value is automatically rounded up or rounded down with regard to the RPM interval. The input of the RCF is only possible if the RCF display (> RCF <) is selected.



Starting steps 1 - 9. Step 9 = shortest starting time, Step 1 = longest starting time.



Brake steps 0 - 9. Step 9 = shortest run-down time, Step 1 = long run-down time, Step 0 = longest run-down time (brakeless run-down).

T/°C Temperature Set Point (only in centrifuges with cooling). Adjustable from -20°C to +40°C, in 1°C intervals. The lowest obtainable temperature depends on the rotor (see Chapter "Anhang/Appendix, Rotoren und Zubehör/Rotors and accessories").

PROG STO Program position on which the program is stored. 9 programs can be stored (program positions 1 - 2 - 3 - ... 9). The programme position # serves as temporary storage for altered adjustments.

14 Entering centrifugation parameter



If no key is pressed for 8 seconds long after the selection or during the input of parameters, the previous values will be shown in the display. The input of parameter then has to be executed again.

- Select the RPM or RCF display with the key **[RCF]**. RCF values are displayed in > <.
- Select the desired parameters using the button **[SELECT]** and set using the knob **⊖**. In order to set continuous operation, the parameters **t/min** and **t/sec** must be set to zero with the **⊖** knob. Continual running is represented in the display by the following symbol, "∞".
- After input of all parameters, press the key **[START/IMPULS]** in order to store the adjustments on the programme position #. As confirmation, ***** ok ***** will be displayed for a short period.



The data on the programme position # will be overwritten with every input of parameters and pressing of the key **[START/IMPULS]**.

15 Programming

15.1 Programme input/alteration

 If no key is pressed for 8 seconds long after the selection or during the input of parameters, the previous values will be shown in the display. The input of parameter then has to be executed again.

- Select the RPM or RCF display with the key **[RCF]**. RCF values are displayed in **> <**.
- Select the desired parameters using the button **[SELECT]** and set using the knob **⊖**.
In order to set continuous operation, the parameters **t/min** and **t/sec** must be set to zero with the **⊖** knob. Continual running is represented in the display by the following symbol, "∞".
- The parameter **PROG STO** can be selected using the button **[SELECT]** and the desired program position set using the knob **⊖**.
- Press the button **[START/IMPULS]** in order to store the setting on the desired program position. ***** ok ***** is displayed briefly as confirmation.
If the key **[START/IMPULS]** is pressed without the parameter **PROG STO** being activated, the settings are always stored in the program place **#**.

 The previous data in the program position is overwritten during saving.

15.2 Programme recall

- Select the parameter **PROG RCL** using the button **[SELECT]** and set the desired program position using the knob **⊖**.
- Press the button **[START/IMPULS]**. The centrifugation data of the selected program position is displayed.
- The parameters can be checked by pressing the button **[SELECT]**.
To leave the parameter display press the button **[OPEN/STOP]** or press no button for a period of 8 seconds.

16 Centrifugation

 When the centrifuge is running, according to EN / IEC 61010-2-020, no persons, dangerous substances or objects may be within the safety margin of 300 mm around the centrifuge.

 If the permissible weight difference within the rotor loading has been exceeded, the drive shuts down during the start-up, the unbalance display lights up, and **IMBALANCE** is displayed.
A centrifugation run can be stopped at any time by pushing the key **[OPEN/STOP]**.
All parameters can be selected and altered during the centrifugation run (see Chapter "Entering centrifugation parameter").
You can switch-over at any time between the RPM and RCF display with the key **[RCF]**. The input of the centrifugation radius is necessary if you are working with the RCF display.
If **⊖ OPEN ⊖ OEFFNEN** is displayed, a further operation of the centrifuge is only possible after opening the lid once.
If **R xx n-max xxxxx** is displayed, then no centrifugation run has taken place as the rotor was changed beforehand, refer to Chapter "Rotor Identification".

- Turn on the mains switch. Switch position **I**.
- Load the rotor and close the centrifuge lid.

16.1 Centrifugation with pre-set time

- Adjusting time or recall a programme with pre-set time (see Chapter "Programming").
- Press the key **[START/IMPULS]**. The LED in the button **[START/IMPULS]** lights up for as long as the rotor turns.
- After expiration of the time or with truncation of the centrifugation run by pushing the key **[OPEN/STOP]**, the run-down is effected with the selected brake step. The brake step is displayed.

During the centrifugation run the rotational speed of the rotor or the subsequently resulting RCF value, the sample temperature (only in centrifuges with cooling) and the remaining time will be displayed.

16.2 Continuous run

- Adjusting the symbol ∞ or recall a continuous run programme (see Chapter "Programming").
- Press the key **(START/IMPULS)**. The LED in the button **(START/IMPULS)** lights up for as long as the rotor turns. The time metering begins at 00:00.
- Press the key **(OPEN/STOP)** in order to stop the centrifugation run. The run-down is effected with the selected brake step. The brake step is displayed.

During the centrifugation run the rotational speed of the rotor or the subsequently resulting RCF value, the sample temperature (only in centrifuges with cooling) and the expired time will be displayed.

16.3 Short-term centrifugation

- Hold down the key **(START/IMPULS)**. The LED in the button **(START/IMPULS)** lights up for as long as the rotor turns. The time metering begins at 00:00.
- Let go of the key **(START/IMPULS)** again in order to stop the centrifugation run. The run-down is effected with the selected brake step. The brake step is displayed.

During the centrifugation run the rotational speed of the rotor or the subsequently resulting RCF value, the sample temperature (only in centrifuges with cooling) and the expired time will be displayed.

17 Emergency Stop

- Press the key **(OPEN/STOP)** twice.

With Emergency Stop the run-down is effected with brake step 9 (shortest run-down time). Brake step 9 is displayed. If brake step 0 was pre-selected, the run-down time is technically longer than with brake step 9.

18 Acoustic Signal

The acoustic signal sounds:

- Upon the appearance of a disturbance in 2 second intervals.
- After completion of a centrifugation run and rotor standstill in 30 second intervals.

The acoustic signal is stopped by opening the lid or pressing any key.

The signal after completion of the centrifugation run can be activated or deactivated in the following manner, if the rotor is at standstill:

- Hold down the key **(SELECT)** for 8 seconds.
After 8 seconds, **SOUND / BELL** appears in the display.
- Set using the knob **OFF** or **ON**.
- Press the key **(START/IMPULS)** in order to store the setting.
As confirmation, ***** ok ***** will be displayed for a short period.

19 Recall hours of operation

Recall hours of operation is only possible during rotor standstill.

- Hold down the key **(SELECT)** for 8 seconds.
After 8 seconds, **SOUND / BELL** appears in the display.
- Press the key **(SELECT)** once again.
The centrifuge's hours of operation (**CONTROL:**) are displayed.
- Press the key **(OPEN/STOP)** to exit the hours of operation recall.

20 Cooling (only in centrifuges with cooling)



The temperature set-point can be adjusted from -20°C to +40°C. The lowest obtainable temperature is dependent on the rotor (see Chapter "Anhang/Appendix, Rotoren und Zubehör/Rotors and accessories").

20.1 Standby-cooling

With rotor standstill and closed lid the centrifugal chamber is cooled to the pre-selected temperature. The temperature set-point is shown in the display.



Standby cooling will be subject to a timed delay after a centrifuge run and the display will show **OPEN** **OEFFNEN**. The delay time can be pre-set in 1 minute steps from 1 to 5 minutes. It is pre-set to 1 minute.

With the rotor standing still and the cover open the delay time can be set as follows:

- Hold down the key  for 8 seconds.
After 8 seconds, **t/min = X** appears in the display.
- Use the rotary button  to set the delay time.
- Press the key  in order to store the setting.
As confirmation, ***** ok ***** will be displayed for a short period.

To leave the delay time display press the key  or do not press any key for a period of 8 seconds.





20.2 Pre-cooling the rotor

- Press the key . The LED in the button  lights up for as long as the rotor turns.
- Press the button  to end the pre-cooling. The run-down is effected with the selected brake step. The brake step is displayed.

During the centrifugation run the rotational speed of the rotor or the subsequently resulting RCF value, the sample temperature and the expired time will be displayed.

The pre-cooling speed can be adjusted in decadic steps from 500 RPM to the max RPM of the rotor. It is pre-adjusted to 2800 RPM.

When the rotor is stationary and the lid open the pre-cooling speed can be set in the following manner:

- Hold down the key  for 8 seconds.
After 8 seconds, **t/min = X** appears in the display.
- Press the key  once again.
The set pre-cooling RPM - **RPM = XXXX** will be displayed.
- Set the desired pre-cooling speed using the knob .
- Press the key  in order to store the setting.
As confirmation, ***** ok ***** will be displayed for a short period.

To leave the pre-cooling RPM display press the key  or do not press any key for a period of 8 seconds.

21 Relative centrifugal force (RCF)

The relative centrifugal force (RCF) is given as a multiple of the acceleration of gravity (g). It is a unit-free value and serves to compare the separation and sedimentation performance.

These values are calculated using the formula below:

$$\text{RCF} = \left(\frac{\text{RPM}}{1000} \right)^2 \times r \times 1,118 \quad \Rightarrow \quad \text{RPM} = \sqrt{\frac{\text{RCF}}{r \times 1,118}} \times 1000$$

RCF = relative centrifugal force

RPM = rotational speed (revolutions per minute)

r = centrifugal radius in mm = distance from the centre of the turning axis to the bottom of the centrifuge.
For more on the centrifugal radius see the chapter "Anhang/Appendix, Rotoren und Zubehör/Rotors and accessories".



The relative centrifugal force (RCF) stands in relation to the revolutions per minute and the centrifugal radius.

22 Centrifugation of materials or mixtures of materials with a density higher than 1.2 kg/dm³

When centrifuging with maximum revolutions per minute the density of the materials or the material mixtures may not exceed 1.2 kg/dm³.

The speed must be reduced for materials or mixtures of materials with a higher density.

The permissible speed can be calculated using the following formula:

$$\text{Reduced speed } (n_{\text{red}}) = \sqrt{\frac{1.2}{\text{Greater density [kg/dm}^3]}} \times \text{maximum speed [RPM]}$$

e.g.: maximum speed RPM 4000, density 1.6 kg/dm³

$$n_{\text{red}} = \sqrt{\frac{1.2 \text{ kg/dm}^3}{1.6 \text{ kg/dm}^3}} \times 4000 \text{ RPM} = 3464 \text{ RPM}$$

In the exceptional case that the maximum loading indicated on the hanger is exceeded, the speed must also be reduced.

The permissible speed can be calculated using the following formula:

$$\text{Reduced speed } (n_{\text{red}}) = \sqrt{\frac{\text{maximum load [g]}}{\text{actual load [g]}}} \times \text{maximum speed [RPM]}$$

e.g.: maximum speed RPM 4000, maximum load 300 g, actual load 350 g

$$n_{\text{red}} = \sqrt{\frac{300 \text{ g}}{350 \text{ g}}} \times 4000 \text{ RPM} = 3703 \text{ RPM}$$

If in doubt you should obtain clarification from the manufacturer.

23 Rotor recognition

Rotor recognition is carried out after each start of the centrifugation run.

If the rotor has been changed, the centrifugation run is canceled after rotor recognition. The rotor code (R xx) and the maximum speed (n-max=xxxxx) of the rotor are displayed.



A further operation of the centrifuge is only possible after a single opening of the lid.

If the maximum speed of the rotor being used is less than the set speed, the speed is limited to the rotor's maximum speed.

24 Emergency release

During a power failure the lid cannot be unlocked by motor. An emergency release has to be executed by hand.



For emergency release disconnect the centrifuge from the mains.
Open the lid only during rotor standstill.

See figure on page 2.

- Switch off the mains switch (switch position "0").
- Look through the window in the lid to be sure that the rotor has come to a standstill.
- Insert the hexagonal wrench key into the bore hole (Fig. 1, A) and carefully rotate by half a turn in clockwise direction until the lid can be opened.
- Pull the hexagon socket head wrench out of the drilling again.
- If the left LED in the **OPEN / STOP** button flashes after the centrifuge is switched on again, press the **OPEN / STOP** button so that the motor-driven lid lock goes into the basic position (opened) again.

25 Maintenance and servicing



The device can be contaminated.



Pull the mains plug before cleaning.

Before any other cleaning or decontamination process other than that recommended by the manufacturer is applied, the user has to check with the manufacturer that the planned process does not damage the device.

- Centrifuges, rotors and accessories must not be cleaned in rinsing machines.
- They may only be cleaned by hand and disinfected with liquids.
- The water temperature must be between 20 – 25°C.
- Only detergents/disinfectants may be used which:
 - have a pH between 5 - 8
 - do not contain caustic alkalis, peroxides, chlorine compounds, acids and alkaline solutions
- In order to prevent appearances of corrosion through cleaning agents or disinfectants, the application guide from the manufacturer of the cleaning agent or disinfectant are absolutely to be heeded.

25.1 Centrifuge (housing, lid and centrifuging chamber)

25.1.1 Surface cleaning and care

- Clean the centrifuge housing and the centrifuging chamber regularly, using soap or a mild detergent and a damp cloth if required. For one thing, this services purposes of hygiene, and it also prevents corrosion through adhering impurities.
- Ingredients of suitable detergents: soap, anionic tensides, non-ionic tensides.
- After using detergents, remove the detergent residue by wiping with a damp cloth.
- The surfaces must be dried immediately after cleaning.
- In the event of condensation water formation, dry the centrifugal chamber by wiping out with an absorbent cloth.
- Lightly rub the rubber seal of the centrifuge chamber with talcum powder or a rubber care product after each cleaning.
- The centrifuging chamber is to be checked for damage once a year.



If damage is found which is relevant to safety, the centrifuge may no longer be put into operation. In this case, notify Customer Service.

25.1.2 Surface disinfection

- If infectious materials penetrates into the centrifugal chamber this is to be disinfected immediately.
- Ingredients of suitable disinfectants: ethanol, n-propanol, isopropyl alcohol, glutardialdehyde, quaternary ammonium compounds.
- After using disinfectants, remove the disinfectant residue by wiping with a damp cloth.
- The surfaces must be dried immediately after disinfecting.

25.1.3 Removal of radioactive contaminants

- The agent must be specifically labelled as being an agent for removing radioactive contaminants.
- Ingredients of suitable agents for removing radioactive contaminants: anionic tensides, non-ionic tensides, polyhydrated ethanol.
- After removing the radioactive contaminants, remove the agent residue by wiping with a damp cloth.
- The surfaces must be dried directly after removing the radioactive contaminants.

25.2 Rotors and Attachments

25.2.1 Cleaning and care

- In order to avoid corrosion and changes in materials, the rotors and accessories have to be cleaned regularly with soap or with a mild cleaning agent and a moist cloth. Cleaning is recommended at least once a week. Contaminants must be removed immediately.
- Ingredients of suitable detergents: soap, anionic tensides, non-ionic tensides.
- After using detergents, remove detergent residue by rinsing with water (only outside of the centrifuge) or wipe off with a damp cloth.
- The rotors and accessories must be dried directly after cleaning.
- Angle rotors, container and hanger made of aluminium are to be lightly greased after drying using acid-free grease, e.g. vaseline.
- In the case of biosafety systems (for further details of available biosafety systems see chapter "Anhang/Appendix, Rotoren und Zubehör/Rotors and accessories"), the packing rings must be checked and cleaned regularly (weekly). The sealing ring is to be replaced immediately upon indication of crack formation, embrittlement or abrasive wear. In order to prevent the packing ring from twisting when opening and closing the cover, the packing ring must be lightly rubbed with talcum powder or a rubber care product.
- In order to prevent corrosion as a result of moisture between the rotor and the motor shaft, the rotor should be disassembled and cleaned at least once a month, and the motor shaft should be lightly greased.
- The rotors and accessories have to be checked monthly for wear and tear and damage due to corrosion. For swing-out rotors, it is important to check the area of the lifting lugs, for hangers, the grooves and the base should be checked for cracks.



Rotors and attachments may no longer be utilised upon indication of wear and tear or corrosion.

- Check the firm seating of the rotor on a weekly basis.

25.2.2 Disinfection

- If infectious material should get on the rotors or accessories, they must be appropriately disinfected.
- Ingredients of suitable disinfectants: glutaraldehyde, propanol, ethyl hexanol, anionic tensides, corrosion inhibitors.
- After using disinfectants, remove disinfectant residue by rinsing with water (only outside of the centrifuge) or wipe off with a damp cloth.
- The rotors and accessories must be dried directly after disinfection.

25.2.3 Removal of radioactive contaminants

- The agent must be specifically labelled as being an agent for the removal of radioactive contaminants.
- Ingredients of suitable agents for removing radioactive contaminants: anionic tensides, non-ionic tensides, polyhydrated ethanol.
- After removing the radioactive contaminants, remove agent residue by rinsing with water (only outside of the centrifuge) or wipe off with a damp cloth.
- The rotors and accessories must be dried directly after removing the radioactive contaminants.

25.2.4 Trunnions

With swing-out rotors the trunnions must be regularly lubricated (Hettich Lubricating Grease No. 4051) in order to ensure consistent swinging out of the hangers.

25.2.5 Rotors and accessories with limited service lives

The use of certain rotors, hangers and accessory parts is limited by time.

These are marked with the maximum permitted number of operating cycles or with an expiration date and the maximum permitted number of operating cycles or just with the expiration date; e.g.:

- "einsetzbar bis Ende: IV. Quartal 2011 / usable until end of: IV. Quarter 2011" or "einsetzbar bis Ende Monat/Jahr: 10/2011 / usable until end of month/year: 10/2011"
- "Max. Lauf Zyklen / max. cycles: 40000".



For safety reasons, rotors, hangers and accessory parts may no longer be used if either the indicated maximum number of operating cycles or the indicated expiration date has been reached.

25.3 Autoclaving

The following accessory can be autoclaved at 121°C / 250°F (20 min):

- Swing-out rotors
- Angle rotors made of aluminum
- Hanger made of metal
- Lid with biocontainment
- Stands
- Reductions

Otherwise you must ask the manufacturer.

No statement can be made about the degree of sterility.



The lids of the rotors and containers must be removed prior to autoclaving.

Autoclaving accelerates the ageing process of plastics. In addition, autoclaving may discolour plastics.

We recommend that the packing rings of the bio-safety system be replaced after autoclaving.

25.4 Centrifuge containers

- With leakiness or after the breakage of centrifuging containers broken container parts and leaked centrifugation material are to be completely removed.
- The rubber inserts as well as the plastic sleeves of the rotors are to be replaced after a glass breakage.



Remaining glass splinters cause further glass breakage!

- If this concerns infectious material, a disinfection process is to be executed immediately.

26 Faults

If the fault cannot be eliminated with the help of the fault table, please inform Customer Service.

Please specify the type of centrifuge and the serial number. Both numbers can be found on the name plate of the centrifuge.



Perform a MAINS RESET:

- Switch off the mains switch (switch position "0").
- Wait at least 10 seconds and then switch on the mains switch again (switch position "I").

Message / fault		Cause	Remedy
No display	---	No voltage. Overvoltage protection tripped out.	<ul style="list-style-type: none"> - Check supply voltage. - Mains switch ON.
TACHO - ERROR	1, 2, 96	Faulty speedometer. Motor, electronics defective.	<ul style="list-style-type: none"> - Open the cover. - Switch off the mains switch (switch position "0"). - Wait at least 10 seconds. - Turn the rotor vigorously by hand. - Switch on the mains switch again (switch position "I"). The rotor must turn during switch-on.
CONTROL - ERROR	8	Error in lid locking or lid closure.	<ul style="list-style-type: none"> - Open lid. - Check the loading of the rotor, see chapter "Loading the rotor". - Repeat the centrifugation run.
IMBALANCE	---	The rotor is unevenly loaded.	<ul style="list-style-type: none"> - Open lid. - Check the loading of the rotor, see chapter "Loading the rotor". - Repeat the centrifugation run.
CONTROL - ERROR	4, 6	Error in lid locking or lid closure.	<ul style="list-style-type: none"> - Perform a MAINS RESET.
N > MAX	5	Rotation too fast	
N < MIN	13	Rotation too slow	
MAINS INTERRUPT	---	Power failure during the centrifugation run. (The centrifugation run was not finished.)	<ul style="list-style-type: none"> - Open lid. - Push START / IMPULS button. - Repeat the centrifugation run if necessary.
ROTORCODE	10.1, 10.2	Incorrect rotor coding	<ul style="list-style-type: none"> - Open lid.
CONTROL-ERROR	21, 22, 25, 27, 29	Error / defect electronics	<ul style="list-style-type: none"> - Perform a MAINS RESET.
CONTROL-ERROR	23	Error / defect controls	
SER I/O - ERROR	30, 31, 33, 36	Error / defect electronics	
° C * - ERROR	51 - 53, 55	Error / defect electronics	
FU / CCI - ERROR	60 - 64, 67, 68, 82 - 86	Error / defect electronics / motor	
SYNC-ERROR	90	Error / defect electronics	
SENSOR-ERROR	91 - 93	Error / defect unbalance sensor	
KEYBOARD-ERROR	---	Error / defect controls	
NO ROTOR	---	No rotor installed	<ul style="list-style-type: none"> - Open lid. - Install rotor.
N > ROTOR MAX	---	Speed in the selected program greater than the maximum speed of the rotor.	<ul style="list-style-type: none"> - Check the set speed. - Reduce the set speed
		The rotor has been changed. The maximum speed of the installed rotor is higher than that of the rotor that was previously used and this has not yet been detected by rotor recognition.	<ul style="list-style-type: none"> - Set a speed up to the maximum speed of the rotor that was previously used. Press the START / IMPULS key to run rotor recognition. See chapter, "Rotor Recognition".

27 Returning Devices



Before returning the device, a transport securing device has to be installed.

If the device or its accessories are returned to Andreas Hettich GmbH & Co. KG, in order to provide protection for people, the environment and materials, it has to be decontaminated and cleaned before being shipped.

We reserve the right to refuse contaminated devices or accessories.

Costs incurred for cleaning and disinfection are to be charged to the customer.

We ask for your understanding in this matter.

28 Disposal

Before disposal, the device must be decontaminated and cleaned to protect people, the environment and property.

When you are disposing of the device, the respective statutory rules must be observed.

Pursuant to guideline 2002/96/EC (WEEE), all devices supplied after August 13, 2005 may not be disposed as part of domestic waste. The device belongs to group 8 (medical devices) and is categorized in the business-to-business field.



The icon of the crossed-out trash can shows that the device may not be disposed as part of domestic waste.

The waste disposal guidelines of the individual EC countries might vary. If necessary, contact your supplier.

Table des matières

1	Usage conforme	53
2	Risques résiduels	53
3	Données techniques	53
4	Consignes de sécurité	56
5	Signification des symboles.....	58
6	Composition de la livraison	58
7	Déballer la centrifugeuse	58
8	Mise en service.....	59
9	Ouvrir et fermer le couvercle.....	59
9.1	Ouvrir le couvercle.....	59
9.2	Fermer le couvercle.....	59
10	Montage et démontage du rotor	60
11	Chargement du rotor	60
12	Fermeture des systèmes de sécurité biologique	61
13	Organes de commande et indicateurs.....	61
13.1	Bouton de réglage.....	61
13.2	Touches de la console de commande.....	61
13.3	Possibilités de réglage	62
14	Saisie des paramètres de centrifugation	63
15	Programmation.....	63
15.1	Saisie / Modification de programme.....	63
15.2	Appel de programme.....	63
16	Centrifugation	64
16.1	Centrifugation avec sélection de temps préalable.....	64
16.2	Centrifugation continue	64
16.3	Centrifugation rapide.....	64
17	Arrêt d'urgence	64
18	Signal sonore	65
19	Interrogation du compteur de durée de fonctionnement.....	65
20	Refroidissement (uniquement sur centrifugeuse avec refroidissement)	65
20.1	Refroidissement en veilleuse	65
20.2	Pré-refroidissement du rotor	65
21	Accélération centrifuge relative (RCF).....	66
22	Centrifugation de matières et de mélanges d'une densité supérieure à 1,2 kg/dm ³	66
23	Identification du rotor.....	66
24	Déverrouillage d'urgence.....	67
25	Entretien et maintenance	67
25.1	Centrifugeuse (boîtier, couvercle et cuve).....	67
25.1.1	Entretien et nettoyage des surfaces.....	67
25.1.2	Désinfection des surfaces.....	67
25.1.3	Décontamination de substances radioactives	68

25.2	Rotors et accessoires	68
25.2.1	Nettoyage et entretien	68
25.2.2	Désinfection	68
25.2.3	Décontamination de substances radioactives	68
25.2.4	Goupilles de fixation	68
25.2.5	Rotors et accessoires à durée d'utilisation limitée	69
25.3	Autoclavage	69
25.4	Réservoirs de centrifugation	69
26	Défauts	70
27	Renvoi d'appareils au fabricant	71
28	Élimination des déchets	71
29	Anhang / Appendix	93
29.1	Rotoren und Zubehör / Rotors and accessories	93

1 Usage conforme

L'appareil dont il est question est un produit médical (centrifugeuse de laboratoire) dans l'esprit de la directive IVD 98/79/CE.

La centrifugeuse sert à la séparation de substances ou mélanges de substances d'une densité maximum de 1,2 kg/dm³. Ce qui comprend, en particulier, tout prélèvement destiné à la préparation de diagnostics In-vitro dans le cadre de la médecine humaine.

La centrifugeuse est exclusivement destinée à cette plage d'utilisation.

Toute utilisation en dehors ou au delà de ce cadre est considérée comme non conforme. L'entreprise Andreas Hettich GmbH & Co. KG décline toute responsabilité pour tout dommage en résultant.

L'utilisation conforme comprend également le respect de toutes les indications contenues dans le mode d'emploi et des travaux d'inspection et d'entretien.

2 Risques résiduels

L'appareil est construit conformément au niveau actuel de la technologie et des règles de sécurité éprouvées. L'utilisation et la manipulation non conforme de cet appareil risquent de menacer la santé et l'intégrité corporelle de l'utilisateur ou de tierces personnes, ou de détériorer l'appareil ou autres biens matériels. Utilisez exclusivement l'appareil conformément à l'usage pour lequel il a été conçu et uniquement s'il est dans un état de fonctionnement technique irréprochable.

Remédier sans attendre à tout dérangement susceptible de porter atteinte à la sécurité.

3 Données techniques

Fabricant	Andreas Hettich GmbH & Co. KG D-78532 Tuttlingen				
Modèle	UNIVERSAL 320		UNIVERSAL 320 R		
Type	1401	1401-01	1406	1406-01	
Tension du réseau ($\pm 10\%$)	200-240 V 1~	100-127 V 1~	200-240 V 1~	240 V 1~	115-127 V 1~
Fréquence du réseau	50 – 60 Hz	50 – 60 Hz	50 Hz	60 Hz	60 Hz
Charge de connexion	400 VA	400 VA	800 VA		950 VA
Consommation de courant	2.0 A	4.0 A	4.0 A		8.0 A
Réfrigérant	----		R 404A		
Capacité max.	4 x 100 ml				
Densité admise	1.2 kg/dm ³				
Vitesse de rotation (RPM)	15000				
Accélération (RCF)	21382				
Energie cinétique	8600 Nm				
Obligation de contrôle (BGR 500)	non				
Conditions ambiantes (EN / IEC 61010-1)	uniquement dans les intérieurs Jusqu'à 2000 m au dessus du niveau de la mer 2°C à 35°C 5°C à 35°C humidité de l'air max. relative 80% pour températures jusqu'à 31°C, décroissant en linéaire jusqu'à 50% de l'humidité relative pour 40°C.				
– Emplacement					
– Hauteur					
– Température ambiante					
– Humidité de l'air					
– Catégorie de surtension (IEC 60364-4-443)	II				
– Degré d'encrassement	2				
Catégorie de protection de l'appareil	I				
Non approprié pour l'usage dans un environnement exposé aux explosions.					
EMV	EN / IEC 61326-1, catégorie B		FCC Class B		
– Emission de parasites, Résistance aux interférences	EN / IEC 61326-1, catégorie B		FCC Class B		
Niveau du bruit (en fonction du rotor)	≤ 68 dB(A)		≤ 58 dB(A)		
Dimensions					
– Largeur	395 mm		401 mm		
– Profondeur	520 mm		695 mm		
– Hauteur	346 mm		346 mm		
Poids	env. 31 kg		env. 53 kg		env. 52 kg

Fabricant	Andreas Hettich GmbH & Co. KG D-78532 Tuttlingen			
Modèle	UNIVERSAL 320 R			
Type	1406-50	1406-51	1406-70	1406-71
Tension du réseau ($\pm 10\%$)	200-240 V 1~	100-127 V 1~	200-240 V 1~	100-127 V 1~
Fréquence du réseau	50 – 60 Hz	50 – 60 Hz	50 – 60 Hz	50 – 60 Hz
Charge de connexion	400 VA	400 VA	400 VA	400 VA
Consommation de courant	2.0 A	4.0 A	2.0 A	4.0 A
Capacité max.	4 x 100 ml			
Densité admise	1.2 kg/dm ³			
Vitesse de rotation (RPM)	15000			
Accélération (RCF)	21382			
Energie cinétique	8600 Nm			
Obligation de contrôle (BGR 500)	non			
Conditions ambiantes (EN / IEC 61010-1)	<p>uniquement dans les intérieurs Jusqu'à 2000 m au dessus du niveau de la mer 2°C à 35°C humidité de l'air max. relative 80% pour températures jusqu'à 31°C, décroissant en linéaire jusqu'à 50% de l'humidité relative pour 40°C.</p>			
– Emplacement				
– Hauteur				
– Température ambiante				
– Humidité de l'air				
– Catégorie de surtension (IEC 60364-4-443)	II			
– Degré d'encrassement	2			
Catégorie de protection de l'appareil	I			
Non approprié pour l'usage dans un environnement exposé aux explosions.				
EMV				
– Emission de parasites, Résistance aux interférences	EN / IEC 61326-1, catégorie B	FCC Class B	EN / IEC 61326-1, catégorie B	FCC Class B
Niveau du bruit (en fonction du rotor)	≤ 58 dB(A)			
Dimensions				
– Largeur	395 mm			
– Profondeur	520 mm			
– Hauteur	346 mm			
Poids	env. 35 kg			

Fabricant	Andreas Hettich GmbH & Co. KG D-78532 Tuttlingen		
Modèle	UNIVERSAL 320 R		
Type	1406-20		1406-21
Tension du réseau ($\pm 10\%$)	200-240 V 1~	240 V 1~	115-127 V 1~
Fréquence du réseau	50 Hz	60 Hz	60 Hz
Charge de connexion	800 VA		950VA
Consommation de courant	4.0 A		8.0 A
Réfrigérant	R 404A		
Capacité max.	4 x 100 ml		
Densité admise	1.2 kg/dm ³		
Vitesse de rotation (RPM)	15000		
Accélération (RCF)	21382		
Energie cinétique	8600 Nm		
Obligation de contrôle (BGR 500)	non		
Conditions ambiantes (EN / IEC 61010-1)	<p>uniquement dans les intérieurs</p> <p>Jusqu'à 2000 m au dessus du niveau de la mer</p> <p>5°C à 35°C</p> <p>humidité de l'air max. relative 80% pour températures jusqu'à 31°C, décroissant en linéaire jusqu'à 50% de l'humidité relative pour 40°C.</p>		
– Emplacement			
– Hauteur			
– Température ambiante			
– Humidité de l'air			
– Catégorie de surtension (IEC 60364-4-443)	II		
– Degré d'encrassement	2		
Catégorie de protection de l'appareil	I		
Non approprié pour l'usage dans un environnement exposé aux explosions.			
EMV			
– Emission de parasites, Résistance aux interférences	EN / IEC 61326-1, catégorie B		FCC Class B
Niveau du bruit (en fonction du rotor)	≤ 58 dB(A)		
Dimensions			
– Largeur	401 mm		
– Profondeur	695 mm		
– Hauteur	346 mm		
Poids	env. 52 kg		

4 Consignes de sécurité



Aucune demande garantie ne pourra être revendiquée auprès du fabricant si les indications données dans ce mode d'emploi ne sont pas toutes respectées.



- **Veiller à la stabilité de la centrifugeuse.**
- **Avant d'utiliser la centrifugeuse, il est indispensable de vérifier la fixation correcte du rotor.**
- **Durant un processus de centrifugation, aucune personne, matière dangereuse et aucun objet ne doivent se trouver dans une zone de sécurité de 300 mm autour de la centrifugeuse selon EN / IEC 61010-2-020.**
- **Les rotors, balanciers et accessoires qui présentent d'importantes traces de corrosion ou des défauts mécaniques ou dont la durée d'utilisation a expiré ne doivent plus être utilisés.**
- **Suspendre immédiatement l'utilisation de la centrifugeuse si la cuve de centrifugeuse présente des dommages susceptibles de porter atteinte à la sécurité.**
- **Les goupilles de fixation des rotors à amortissement doivent être graissées régulièrement (graisse de lubrification Hettich n° 4051) de manière à assurer le balancement régulier de la suspension.**
- **Concernant les centrifugeuses sans réglage de température, il peut y avoir un réchauffement dans la cuve de centrifugeuse en cas de température ambiante élevée et/ou d'utilisation fréquente de l'appareil. Il n'est donc pas possible d'exclure une modification de l'échantillon due à la température.**

- **Il importe de lire et de respecter le mode d'emploi avant la mise en service de la centrifugeuse. Seules les personnes ayant lu et compris le mode d'emploi sont autorisées à manipuler l'appareil.**
- Outre le mode d'emploi et les réglementations contraignantes relatives à la prévention des accidents, il importe également de respecter les règles spécifiques et communément admises en matière de sécurité et de travail. Le mode d'emploi doit être complété des dispositions nationales applicables à la prévention des accidents et à la protection de l'environnement.
- La centrifugeuse a été construite conformément à l'état actuel de la technique et son fonctionnement est sûr. Elle peut cependant présenter des dangers pour l'utilisateur ou des tiers si son utilisation n'est pas confiée à un personnel dûment formé, est inadéquate ou non conforme à sa destination.
- Pendant le fonctionnement, la centrifugeuse ne devra pas être déplacée ou être heurtée.
- En cas de défaillance ou en cas de déverrouillage d'urgence, ne jamais intervenir dans l'appareil lorsque le rotor tourne.
- Afin d'éviter les dommages causés par la condensation en passant d'un local froid à un local chaud, il faut soit réchauffer la centrifugeuse en la laissant pendant au moins 3 heures dans le local chaud avant de la raccorder au secteur, soit la faire fonctionner pendant 30 minutes dans le local froid pour la chauffer.
- Pour cet appareil, vous ne devez utiliser que des rotors et des accessoires homologués par le fabricant (voir chapitre "Anhang/Appendix, Rotoren und Zubehör/Rotors and accessories"). Avant d'utiliser des récipients de centrifugation qui ne sont pas présentés dans le chapitre "Annexe/Appendix, rotors et accessoire/Rotors and accessories", l'utilisateur doit s'assurer auprès du fabricant qu'il peut les utiliser.
- Le rotor de la centrifugeuse doit uniquement être chargé conformément au chapitre "Chargement du rotor".
- Dans le cas de la centrifugation à la vitesse maximale, la densité des substances et des mélanges de substances ne doit pas excéder 1,2 kg/dm³.
- Il est interdit de procéder à des centrifugations en présence de défauts d'équilibrage.
- La centrifugeuse ne doit pas être exploitée dans un environnement explosif.
- Il est interdit de procéder à des centrifugations :
 - avec des matières inflammables ou explosives,
 - avec des matières susceptibles de réagir chimiquement ou de dégager d'importantes quantités d'énergie.
- En cas de centrifugation de substances dangereuses ou de substances mixtes toxiques, radioactives ou contaminées par des micro-organismes pathogènes, il incombe à l'utilisateur de prendre les mesures ad hoc.

Il faut systématiquement utiliser des récipients de centrifugation avec des bouchons spéciaux à vis destinés aux substances dangereuses. Dans le cas des substances des groupes de risques 3 et 4, il faut utiliser un système de sécurité biologique en plus des récipients de centrifugation pouvant être obturés (voir le manuel "Laboratory Biosafety Manual" publié par l'Organisation Mondiale de la Santé).

Dans un système de sécurité biologique, un joint biologique (bague d'étanchéité) empêche la fuite de gouttelettes et d'aérosols.

Lorsque la suspension d'un système de sécurité biologique est utilisée sans couvercle, il faut enlever la bague d'étanchéité de la suspension pour éviter de l'endommager pendant le cycle de centrifugation. Les bagues endommagées ne doivent plus être utilisées pour assurer l'étanchéité le système de sécurité biologique.

En l'absence d'un système de sécurité biologique, une centrifugeuse n'est pas étanche du point de vue microbiologique au sens de la norme EN / IEC 61010-2-020.

Lors de la fermeture d'un système de sécurité biologique, il faut se conformer aux instructions du chapitre "Fermeture des systèmes de sécurité biologique".

Pour ce qui concerne les systèmes à sécurité biologique, voir le chapitre "Anhang/Appendix, Rotoren und Zubehör/Rotors and accessories". Dans le doute vous pouvez obtenir les informations auprès du fabricant.

- Il est interdit de centrifuger des matières fortement corrosives pouvant réduire la résistance mécanique des rotors, des supports et des accessoires.
- Les réparations ne peuvent être effectuées que par une personne autorisée à cet effet par le fabricant.
- Utiliser uniquement les pièces de rechange originales et les accessoires d'origine homologués par les Etablissements Andreas Hettich GmbH & Co. KG.
- Les dispositions de sécurité suivantes font foi :
EN / IEC 61010-1 et EN / IEC 61010-2-020 ainsi que les dérogations nationales.
- La sécurité et la fiabilité de la centrifugeuse seront uniquement garanties si :
 - la centrifugeuse est utilisée conformément aux instructions du mode d'emploi,
 - l'installation électrique du site de la centrifugeuse est conforme aux prescriptions EN / IEC,
 - les contrôles prescrits selon BGV A1, BGR 500 sont effectués par un personnel spécialisé averti.

5 Signification des symboles



Symbole sur l'appareil :

Attention, zone de danger général.

Avant utilisation de l'appareil, il est indispensable de lire le mode d'emploi et de respecter les consignes relatives à la sécurité!



Symbole dans ce document:

Attention, zone de danger général.

Ce symbole indique des consignes de sécurité et signale des situations pouvant être sources de danger.

Le non-respect de ces instructions peut entraîner des dégâts matériels et personnels.



Symbole sur l'appareil et dans ce document:

Avertissement de menace biologique pour l'environnement.



Symbole dans ce document:

Ce symbole signale des informations importantes.



Symbole sur l'appareil et dans ce document:

Symbole pour la collecte séparée des appareils électriques et électroniques, conformément à la directive 2002/96(EG (WEEE). L'appareil fait partie du groupe 8 (appareils de médecine).

Utilisation dans les pays de l'Union Européenne ainsi qu'en Norvège et en Suisse.

6 Composition de la livraison

- 1 Câble de connexion
- 1 Clé hexagonale
- 1 Graisse pour tourillon porteur
- 1 Mode d'emploi
- 1 Fiche de consignes pour le transport

Le(s) rotor(s) et accessoires correspondant sont livrés selon les spécifications de la commande.

7 Déballer la centrifugeuse

- Soulever le carton et retirer le matériau d'amortissement.

-



Ne pas saisir sur le tableau de commande frontal pour soulever.

Tenir compte du poids de la centrifugeuse, voir au chapitre "Données techniques".

Avec un nombre suffisant d'aides, soulever la centrifugeuse sur les deux faces et la déposer sur la table de laboratoire.

8 Mise en service

- Selon la norme sur les appareils de laboratoire EN / IEC 61010-2-020, l'installation locale doit être équipée d'un interrupteur d'arrêt d'urgence pour sectionner l'alimentation du secteur en cas de défaut. Cet interrupteur doit être éloigné de la centrifugeuse, de préférence hors de la pièce dans laquelle est la centrifugeuse ou près de la porte.
- Retirer du fond du carter les dispositifs de sécurité pour le transport, voir pour cela la fiche de données "Dispositifs de sécurité pour le transport".
- Placer la centrifugeuse sur un emplacement approprié de manière à ce qu'elle soit stable et mettre de niveau. Lors de la mise en place, il faut respecter la zone de sécurité exigée de 300mm autour de la centrifugeuse selon EN / IEC 61010-2-020.



Durant un processus de centrifugation, aucune personne, matière dangereuse et aucun objet ne doivent se trouver dans une zone de sécurité de 300 mm autour de la centrifugeuse selon EN / IEC 61010-2-020.

- Ne pas placer d'objet devant la grille de ventilation. Ménager un espace de ventilation de 300 mm autour de la grille.
- Pour la centrifugeuse de type 1406-20, 1406-21, raccorder l'alimentation en azote selon la fiche de consignes jointe AH1406-20XX.
Pour la centrifugeuse de type 1406-50, 1406-51, raccorder le système pour chauffer/réfrigérer selon la fiche de consignes jointe AH1406-50XX.
Pour la centrifugeuse de type 1406-70, 1406-71, raccorder le système pour chauffer/réfrigérer et l'alimentation en azote selon la fiche de consignes jointe AH1406-70XX.



Le raccord de la centrifugeuse doit absolument être effectué conformément à la fiche de consignes jointe.
Observer impérativement la feuille de consignes jointe.

- Vérifier que la tension de secteur est identique à la mention de la plaque signalétique.
- Raccorder la centrifugeuse à une prise de secteur normalisée au moyen du câble de connexion. Puissance connectée voir chapitre "Données techniques".
- Activer l'interrupteur de secteur. Amener l'interrupteur en position "1".
Le type de la machine et la version du programme s'affichent, les diodes s'allument. Après 8 secondes, **OPEN** **OEFFNEN** s'affiche et la DEL gauche dans la touche **STOP/OPEN** clignote.
- Ouvrir le capot.
Les dernières données de centrifuge utilisées s'affichent.

9 Ouvrir et fermer le couvercle

9.1 Ouvrir le couvercle



Le capot ne peut être ouvert que lorsque la centrifugeuse est sous tension et que le rotor est à l'arrêt. Dans les autres cas, voir le chapitre, "Déverrouillage d'urgence".

- Appuyer sur la touche **OPEN/STOP**. Le couvercle est déverrouillé par le moteur et la DEL gauche située dans la touche **OPEN/STOP** s'éteint.

9.2 Fermer le couvercle



Ne pas mettre les doigts entre le couvercle et le boîtier.
Ne pas laisser tomber le couvercle pour le fermer.

Lorsque la DEL gauche de la touche **OPEN/STOP** clignote, appuyer la touche **OPEN/STOP** pour amener le verrouillage motorisé du couvercle en position de base (ouvert).

- Mettre le couvercle en place et appuyer légèrement sur la bordure avant du couvercle. Le verrouillage est automatique. La DEL de gauche intégrée dans la touche **OPEN/STOP** s'allume.

10 Montage et démontage du rotor

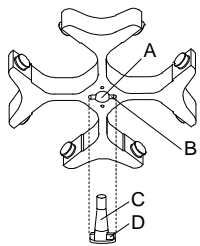

- Nettoyer l'arbre d'entraînement (C) et l'alésage du rotor (A) et enduire ensuite l'arbre d'entraînement d'une pellicule de graisse. Les particules d'impuretés entre l'arbre d'entraînement et le rotor réduisent la stabilité d'assise du rotor et provoquent un fonctionnement irrégulier.
- Enfiler le rotor à la verticale sur l'arbre d'entraînement. Le taquet de l'arbre d'entraînement (D) doit être logé dans la rainure du rotor (B). L'orientation de la rainure est indiquée sur le rotor.
- Serrer l'écrou de fixation du rotor avec la clé de la livraison en tournant dans le sens horloger.
- Vérifier la stabilité d'assise du rotor.
- Démontage du rotor: Desserrer l'écrou de fixation par rotation dans le sens anti-horloger jusqu'à ce que le rotor puisse être détaché par pression. En exerçant une légère pression, détacher le rotor du cône de l'arbre d'entraînement. Dévisser l'écrou de fixation jusqu'à ce que le rotor soit détaché de l'arbre d'entraînement.

11 Chargement du rotor



Des récipients standard de centrifugation en verre sont résistants jusqu' à un ACR de 4000 (DIN 58970, partie 2).

- Vérifier la stabilité d'assise du rotor.
- Dans le cas des rotors à balanciers, toutes les positions des rotors doivent être équipées avec les **mêmes** balanciers. Certains balanciers sont désignés avec le numéro de la place du rotor. Ces balanciers doivent exclusivement être installés dans la place de rotor correspondante. Les balanciers désignés par un numéro de set, comme S001/4 par exemple, doivent exclusivement être utilisés dans le set.
- Le chargement des rotors et des balanciers doit être nécessairement symétrique. Les conteneurs de centrifugation doivent être uniformément répartis sur toutes les positions du rotor. Pour les combinaisons possibles, voir le Chapitre "Anhang/Appendix, Rotoren und Zubehör/Rotors and accessories". Dans le cas des rotors à angle fixe, il faut charger tous les logements possibles du rotor, voir au chapitre "Annexe/Appendix, Rotors et accessoires/Rotors and accessories".

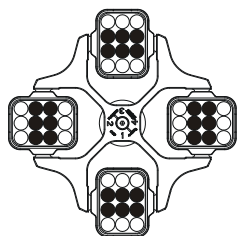

Rotor uniformément chargé

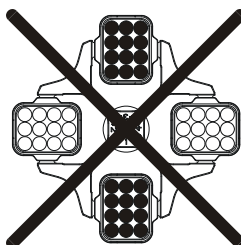

Non autorisé !
Rotor irrégulièrement chargé

- Certains dispositifs de suspension indiquent soit le poids maximum de la charge, soit le poids total maximum comprenant charge et dispositifs. Pour les cas d'exception, voir le chapitre "Centrifugation de matières et de mélanges d'une densité supérieure à 1,2 kg/dm³". L'indication du poids de la charge maximale comprend le poids total de la réduction, châssis, récipient de centrifugation et contenu.
- Dans le cas des récipients à garniture de caoutchouc, les récipients de centrifugation doivent avoir le même nombre de garnitures dans la partie inférieure.
- Les récipients de centrifugation doivent toujours être remplis hors de la centrifugeuse.
- Aucun liquide ne doit parvenir dans le bol de centrifugeuse pendant le remplissage et le déplacement des balanciers.
- La quantité maximale de remplissage indiquée par le fabricant pour les récipients de centrifugation ne doit pas être dépassée.
- La hauteur de remplissage des récipients sera autant que possible égale pour maintenir les différences de poids entre les récipients de centrifugation aussi réduites que possible .

12 Fermeture des systèmes de sécurité biologique



Pour garantir l'étanchéité, le couvercle d'un système de sécurité biologique doit être solidement fermé.

Pour éviter de fausser la bague d'étanchéité en ouvrant et en fermant le couvercle, il faut frotter légèrement la bague d'étanchéité avec de la poudre de talc ou un produit d'entretien pour caoutchouc.

Lorsque la suspension d'un système de sécurité biologique est utilisée sans couvercle, il faut enlever la bague d'étanchéité de la suspension pour éviter de l'endommager pendant le cycle de centrifugation. Les bagues endommagées ne doivent plus être utilisées pour assurer l'étanchéité le système de sécurité biologique.

Pour ce qui concerne les systèmes à sécurité biologique, voir le chapitre "Anhang/Appendix, Rotoren und Zubehör/Rotors and accessories". Dans le doute vous pouvez obtenir les informations auprès du fabricant.

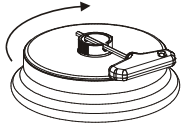

Couvercle à fermeture vissée et alésage dans la poignée tournante :

- Insérer la clé fournie avec l'équipement dans l'alésage de la poignée tournante et fermer solidement le couvercle en le vissant dans le sens des aiguilles d'une montre.

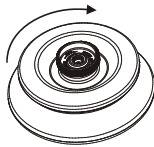

Couvercle à fermeture vissée sans alésage dans la poignée tournante :

- Fermer solidement le couvercle à la main, en le vissant dans le sens des aiguilles d'une montre.

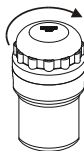

Couvercle à fermeture vissée :

- Fermer solidement le couvercle à la main, en le vissant dans le sens des aiguilles d'une montre.

13 Organes de commande et indicateurs

Voir illustration sur la page 2.

Fig. 2, Fig. 3: Console des indicateurs et organes de commande

13.1 Bouton de réglage



Pour le réglage des paramètres individuels.

Pour faire décroître la valeur, tourner le bouton dans le sens anti-horaire. Pour augmenter la valeur, tourner le bouton dans le sens horaire.

13.2 Touches de la console de commande



- Touche de sélection des différents paramètres. Les paramètres sont sélectionnés l'un après l'autre en appuyant sur la touche.



- Démarrer le cycle de centrifugation. La DEL intégrée dans la touche reste allumée pendant le cycle de centrifugation, tant que le rotor tourne.
- Centrifugation courte durée. Le cycle de centrifugation est exécuté tant que l'action est maintenue sur la touche. La DEL intégrée dans la touche reste allumée pendant le cycle de centrifugation, tant que le rotor tourne.
- Sauvegarder les entrées et les modifications.



- Terminer le cycle de centrifugation. Le rotor est décéléré à la vitesse de freinage sélectionnée. La DEL intégrée dans la touche, à droite, reste allumée jusqu'à l'arrêt du rotor. A l'arrêt du rotor, la DEL gauche intégrée dans la touche clignote. L'ARRET D'URGENCE est activé en appuyant deux fois sur la touche.
- Déverrouiller le couvercle. La DEL de gauche intégrée dans la touche s'éteint.
- Quitter l'écran de saisie des paramètres.



- Commuter entre l'écran RPM et l'écran RCF. Les valeurs RCF sont affichées en > <.



- Démarrer le refroidissement préliminaire. La vitesse de refroidissement préliminaire est réglable. Elle est pré-réglée sur 2800 RPM.

13.3 Possibilités de réglage

PROG RCL Position de programme du programme appelé.

t/min Durée de fonctionnement. Réglable de 0 à 99 min, par pas de 1 min.

t/sec Durée de fonctionnement. Réglable de 0 à 59 s, par pas de 1 seconde.

Fonctionnement continu " ∞ ". Forcer sur zéro les paramètres **t/min** et **t/sec**.

RPM Vitesse. Il est possible de régler une valeur numérique comprise entre 500 RPM et la vitesse de rotation maximale du rotor. Pour la vitesse maximale de rotation du rotor, se reporter au chapitre "Anhang/Appendix, Rotoren und Zubehör/Rotors and accessories". Réglable par pas de 10.

RAD/mm Rayon de centrifugation. Valeurs en mm. Pour la saisie de rayon de centrifugation, voir le Chapitre "Anhang/Appendix, Rotoren und Zubehör/Rotors and accessories". La saisie de rayon n'est possible que quand l'écran RCF (> RCF <) est sélectionné.

RCF Accélération relative de centrifugation. Il est possible de régler une valeur numérique dont découle une vitesse de rotation située entre 500 RPM et la vitesse maximale de rotation du rotor. Réglage par incréments de 1 jusqu'à 100, par incréments de 10 à partir de 100. La valeur RCF est arrondie automatiquement au chiffre supérieur/inférieur en fonction de l'incrément de vitesse. La saisie de RCF n'est possible que quand l'écran RCF (> RCF <) est sélectionné.

 Etages de montée en puissance de 1 à 9. Etage 9 = temps de montée en puissance le plus court, étage 1 = temps de montée en puissance le plus long.

 Etages de décélération de 0 à 9. Etage 9 = temps de décélération le plus court, étage 1 = étage de décélération long, étage 0 = étage de décélération le plus long (décélération par inertie, sans freinage).

T/°C Valeur de température de consigne (uniquement sur centrifugeuse avec refroidissement). Réglage de -20 °C à +40 °C, par incréments de 1 °C. La température la plus basse pouvant être établie est fonction du rotor (voir le Chapitre "Anhang/Appendix, Rotoren und Zubehör/Rotors and accessories").

PROG STO Position de programme sur laquelle le programme est sauvegardé. 9 programmes peuvent être sauvegardés (positions de programme 1 - 2 - 3 - ... 9). La position de programme # sert de mémoire temporaire pour la modification des réglages.

14 Saisie des paramètres de centrifugation



Après sélection de paramètres et pendant la sélection des paramètres, l'indicateur bascule sur les valeurs précédentes si aucune action n'exécute sur les touches pendant 8 secondes. Il est alors nécessaire de recommencer la saisie des paramètres.

- Sélectionner l'indicateur RPM ou RCF en appuyant sur la touche **[RCF]**. Les valeurs RCF sont affichées en **> <**.
- Sélectionner les paramètres souhaités en appuyant sur la touche **[SELECT]** et ajuster sur le bouton radio **○**. Afin de régler le fonctionnement continu, il faut mettre les paramètres **t/min** et **t/sec** à zéro avec le bouton rotatif **○**. Le fonctionnement continu est indiqué dans l'affichage par le symbole "∞".
- Après entrée de tous les paramètres, appuyer sur la touche **[START/IMPULS]** pour sauvegarder les réglages sur la position de programme **#**. La saisie est confirmée par affichage de ***** ok ***** pendant un instant.



Les données de la position de programme **#** sont écrasées par entrée de paramètres et en appuyant sur la touche **[START/IMPULS]**.

15 Programmation

15.1 Saisie / Modification de programme



Après sélection de paramètres et pendant la sélection des paramètres, l'indicateur bascule sur les valeurs précédentes si aucune action n'exécute sur les touches pendant 8 secondes. Il est alors nécessaire de recommencer la saisie des paramètres.

- Sélectionner l'indicateur RPM ou RCF en appuyant sur la touche **[RCF]**. Les valeurs RCF sont affichées en **> <**.
- Sélectionner les paramètres souhaités en appuyant sur la touche **[SELECT]** et ajuster sur le bouton radio **○**. Afin de régler le fonctionnement continu, il faut mettre les paramètres **t/min** et **t/sec** à zéro avec le bouton rotatif **○**. Le fonctionnement continu est indiqué dans l'affichage par le symbole "∞".
- Sélectionner le paramètre **PROG STO** sur le bouton radio **[SELECT]** et régler la position de programme souhaitée sur le bouton radio **○**.
- Pour sauvegarder les configurations sous la position de programme souhaitée, appuyer sur la touche **[START/IMPULS]**. La saisie est confirmée par l'affichage bref de ***** ok *****.
Si vous appuyez sur la touche **[START/IMPULS]**, sans avoir sélectionné le paramètre **PROG STO**, les réglages sont alors toujours enregistrés sur l'emplacement de programme **#**.



Les données précédentes de la position de programme sont écrasées par écriture.

15.2 Appel de programme

- Sélectionner le paramètre **PROG RCL** en appuyant sur la touche **[SELECT]** et configurer la position de programme souhaitée sur le bouton radio **○**.
- Appuyer sur la touche **[START/IMPULS]**. Les données de centrifugation pour la position de programme sélectionnée sont affichées.
- Vérifier les paramètres en appuyant sur la touche **[SELECT]**.
Pour quitter l'afficheur des paramètres, appuyer sur la touche **[OPEN/STOP]** ou attendre 8 secondes sans exécuter aucune action.

16 Centrifugation



Durant un processus de centrifugation, aucune personne, matière dangereuse et aucun objet ne doivent se trouver dans une zone de sécurité de 300 mm autour de la centrifugeuse selon EN / IEC 61010-2-020.



L'entraînement est stoppé en phase de montée en puissance si la différence de tare admissible a été dépassée pendant le chargement du rotor, l'indicateur de déséquilibre s'allume et la mention **IMBALANCE** est affichée.

La centrifugation peut être stoppée n'importe quand en appuyant sur la touche **OPEN / STOP**.

Il est possible de sélectionner et de modifier tous les paramètres pendant la centrifugation (voir le Chapitre "Saisie des paramètres de centrifugation").

Il est possible de basculer n'importe quand sur l'indicateur RPM et RCF en appuyant sur la touche **RCF**. Pour travailler avec l'indicateur RCF, il est nécessaire d'entrer le brayon de centrifugation.

Après affichage de **OPEN OEFFNEN** (= OUVRIR) la commande de centrifugeuse n'est possible qu'après avoir ouvert le couvercle une fois.

Si **R xx n-max xxxxx** est affiché, la marche de centrifugation n'a pas été exécutée en raison du changement du rotor, voir chapitre "Identification de rotor".

- Mettre la centrifugeuse sous tension. Amener l'interrupteur en position I.
- Charger le rotor et fermer le couvercle de centrifugeuse.

16.1 Centrifugation avec sélection de temps préalable

- Régler le temps et appeler un programme avec sélection de temps préalable (voir le Chapitre "Programmation").
- Appuyer sur la touche **START / IMPULS**. La DEL incorporée dans la touche **START / IMPULS** reste allumée tant que le rotor tourne.
- La décélération selon l'étage de freinage sélectionné est exécutée après écoulement du temps ou interruption de la centrifugation en appuyant sur la touche **OPEN / STOP**. L'étage de freinage est affiché.

Pendant la centrifugation, l'afficheur donne la vitesse du rotor ou la valeur RCF résultants, la température des échantillons (uniquement sur centrifugeuse avec refroidissement) et la durée restante.

16.2 Centrifugation continue

- Ajuster sur l'icône ∞ ou appeler un programme de centrifugation continue (voir le Chapitre "Programmation").
- Appuyer sur la touche **START / IMPULS**. La DEL incorporée dans la touche **START / IMPULS** reste allumée tant que le rotor tourne. Le compte du temps commence à 00:00.
- Pour stopper la centrifugation, appuyer sur la touche **OPEN / STOP**. La décélération est exécutée selon l'étage de freinage sélectionné. L'étage de freinage est affiché.

Pendant la centrifugation, l'afficheur donne la vitesse du rotor ou la valeur RCF résultants, la température des échantillons (uniquement sur centrifugeuse avec refroidissement) et la durée restante.

16.3 Centrifugation rapide

- Appuyer sur la touche **START / IMPULS** et maintenir l'action. La DEL incorporée dans la touche **START / IMPULS** reste allumée tant que le rotor tourne. Le compte du temps commence à 00:00.
- Pour stopper la centrifugation rapide, cesser l'action sur la touche **START / IMPULS**. La décélération est exécutée selon l'étage de freinage sélectionné. L'étage de freinage est affiché.

Pendant la centrifugation, l'afficheur donne la vitesse du rotor ou la valeur RCF résultants, la température des échantillons (uniquement sur centrifugeuse avec refroidissement) et la durée restante.

17 Arrêt d'urgence

- Appuyer 2 fois sur la touche **OPEN / STOP**

La décélération est exécutée sur l'étage 9 (temps de décélération le plus court) en cas d'arrêt d'urgence L'étage de freinage 9 est affiché.

Si l'étage de freinage 0 a été sélectionné, la décélération est plus longue, pour des raisons technique, que pour l'étage de freinage 9.

18 Signal sonore

Le signal sonore retentit :

- en présence d'un défaut à un intervalle de 2 s.
- au terme de la centrifugation et après immobilisation du rotor, à un intervalle de 30 s.

Le signal sonore cesse après ouverture du couvercle, en appuyant sur une touche quelconque.

Pour activer / désactiver le signal sonore après la centrifugation, alors que le rotor est immobilisé, procéder comme suit :

- Appuyer sur la touche **[SELECT]** pendant 8 s.
Après 8 s, la mention **SOUND / BELL** est affichée.
- Régler sur le bouton radio **OFF** (arrêt) et **ON** (marche).
- Appuyer sur la touche **[START/IMPULS]** pour sauvegarder le réglage.
La saisie est confirmée par affichage de ***** ok ***** pendant un instant.

19 Interrogation du compteur de durée de fonctionnement

Il n'est possible d'interroger le compteur de durée de fonctionnement qu'à l'arrêt du rotor.

- Appuyer sur la touche **[SELECT]** pendant 8 s.
Après 8 s, la mention **SOUND / BELL** est affichée.
- Appuyer une nouvelle fois sur la touche **[SELECT]**
La durée de fonctionnement (**CONTROL:**) de la centrifugeuse est affichée.
- Pour quitter l'interrogation de durée de fonctionnement, appuyer sur la touche **[OPEN/STOP]**.

20 Refroidissement (uniquement sur centrifugeuse avec refroidissement)

La température de consigne peut être réglée sur une plage de -20 °C à +40 °C. Le minimum de température possible est fonction du rotor (voir le Chapitre "Anhang/Appendix, Rotoren und Zubehör/Rotors and accessories").

20.1 Refroidissement en veilleuse

A l'arrêt du rotor et lorsque le couvercle est fermé, le bol de centrifugeuse est refroidi à la température sélectionnée. La température de consigne est indiquée sur l'afficheur.

Après une marche centrifuge, le refroidissement se met en veille après une temporisation, et **OPEN** / **OFFNEN** s'affiche. Vous pouvez régler la temporisation de 1 à 5 minutes en étapes de 1 minute. Elle est pré-réglée sur 1 minute.

Vous pouvez régler la temporisation lorsque le rotor est à l'arrêt et le couvercle ouvert en procédant comme suit :

- Appuyer sur la touche **[X]** pendant 8 secondes.
Au bout de 8 secondes, la mention **t/min = X** s'affiche.
- Régler la temporisation avec le bouton tournant **○**.
- Appuyer sur la touche **[START/IMPULS]** pour sauvegarder le réglage.
La saisie est confirmée par affichage de ***** ok ***** pendant un instant.

Pour quitter l'affichage temporisation, appuyer sur la touche **[OPEN/STOP]** ou ne pas appuyer de touche pendant 8 secondes.

20.2 Pré-refroidissement du rotor

- Appuyer sur la touche **[X]**. La DEL incorporée dans la touche **[START/IMPULS]** reste allumée tant que le rotor tourne.
- Pour abandonner le refroidissement préliminaire, appuyer sur la touche **[OPEN/STOP]**. La décélération est exécutée selon l'étage de freinage sélectionné. L'étage de freinage est affiché.

Pendant la centrifugation, l'afficheur donne la vitesse du rotor ou la valeur RCF résultants, la température des échantillons et la durée restante.

Vous pouvez régler la vitesse du pré-refroidissement de 500 tours/min jusqu'à la vitesse maximale du rotor en étapes de 10. Elle est pré-réglée sur 2800 RPM.

La vitesse de refroidissement préliminaire est réglée de la manière suivante, alors que le rotor est à l'arrêt et que le couvercle est ouvert:

- Appuyer sur la touche **[X]** pendant 8 secondes.
Après 8 secondes, la mention **t/min = X** est affichée.
- Appuyer une nouvelle fois sur la touche **[X]**
La vitesse de pré-refroidissement réglée en tours/min = **XXXX** s'affiche.
- Régler la vitesse de refroidissement préliminaire sur le bouton radio **○**.
- Appuyer sur la touche **[START/IMPULS]** pour sauvegarder le réglage.
La saisie est confirmée par affichage de ***** ok ***** pendant un instant.

Pour quitter l'affichage de la vitesse de pré-refroidissement, appuyer la touche **[OPEN/STOP]** ou ne pas appuyer de touche pendant 8 secondes.

21 Accélération centrifuge relative (RCF)

L'accélération centrifuge relative (RCF) est indiquée en tant que multiple de l'accélération gravitationnelle (g). Il s'agit d'une valeur dépourvue d'unité, qui sert à la comparaison entre la puissance de séparation et de sédimentation.

Le calcul s'effectue à l'aide de la formule suivante:

$$\text{RCF} = \left(\frac{\text{RPM}}{1000} \right)^2 \times r \times 1,118 \quad \Rightarrow \quad \text{RPM} = \sqrt{\frac{\text{RCF}}{r \times 1,118}} \times 1000$$

RCF = accélération centrifuge relative

RPM = régime

r = rayon de centrifugation en mm = distance qui sépare le centre de l'axe de rotation du fond de la cuve de centrifugation. Rayon de centrifugation voir chapitre "Anhang/Appendix, Rotoren und Zubehör/Rotors and accessories".



L'accélération centrifuge relative (RCF) est dépendante du régime et du rayon de centrifugation.

22 Centrifugation de matières et de mélanges d'une densité supérieure à 1,2 kg/dm³

Dans le cas de la centrifugation à la vitesse maximale, la densité des substances et des mélanges de substances ne doit pas excéder 1,2 kg/dm³. Réduire la vitesse de rotation pour les matières et mélanges ayant une densité supérieure.

La vitesse de rotation autorisée se calcule de la manière suivante:

$$\text{Vitesse de centrifugation lente (n}_{\text{red}}) = \sqrt{\frac{1,2}{\text{densité supérieure [kg/dm}^3]}} \times \text{Vitesse de rotation maximum [RPM]}$$

Exemple: Vitesse de rotation maximum RPM 4000, densité 1,6 kg/dm³

$$n_{\text{red}} = \sqrt{\frac{1,2 \text{ kg/dm}^3}{1,6 \text{ kg/dm}^3}} \times 4000 \text{ RPM} = 3464 \text{ RPM}$$

Dans le cas exceptionnel de dépassement de la charge maximum indiquée sur la suspension, réduire également la vitesse de rotation.

La vitesse de rotation autorisée se calcule de la manière suivante:

$$\text{Vitesse de centrifugation lente (n}_{\text{red}}) = \sqrt{\frac{\text{Charge maximum [g]}}{\text{Charge réelle [g]}}} \times \text{Vitesse de rotation maximum [RPM]}$$

Exemple: Vitesse de rotation maximum RPM 4000, Charge maximum 300 g, Charge réelle 350 g

$$n_{\text{red}} = \sqrt{\frac{300 \text{ g}}{350 \text{ g}}} \times 4000 \text{ RPM} = 3703 \text{ RPM}$$

En cas d'incertitude, prendre contact avec le fabricant.

23 Identification du rotor

Une identification du rotor est effectuée après le démarrage de chaque cycle de centrifugation.

Si le rotor a été remplacé, le cycle de centrifugation s'interrompt après l'identification du rotor. L'afficheur indique le code (R xx) et la vitesse de rotation maximale (n-max=xxxxx) du rotor.



Toute commande ultérieure de la centrifuge n'est possible qu'après une ouverture du couvercle.

Si la vitesse de rotation maximale du rotor utilisé est inférieure à la vitesse de rotation paramétrée, la vitesse de rotation effective est limitée à la vitesse de rotation maximale du rotor.

24 Déverrouillage d'urgence

En cas de panne de courant, le couvercle ne peut pas être déverrouillé avec le moteur. Il est nécessaire d'exécuter un déverrouillage manuel.



Avant d'exécuter le déverrouillage manuel, retirer la fiche de l'alimentation.
Attendre que le rotor est à l'arrêt pour ouvrir le couvercle.

Voir illustration sur la page 2.

- Couper l'interrupteur de secteur (position de l'interrupteur "0").
- Regarder par la fenêtre située sur le couvercle pour s'assurer que le rotor est immobile.
- Insérer horizontalement la clé mâle coudée à six pans creux dans l'orifice (Fig. 1, A) et tourner avec précaution d'un demi-tour dans le sens des aiguilles d'une montre jusqu'à ce que le couvercle puisse être ouvert.
- Retirer la clé à six pans hors de l'alésage.
- Si, après la remise sous tension de la centrifugeuse, la DEL gauche de la touche **OPEN/STOP** clignote, appuyer la touche **OPEN/STOP** pour que le verrouillage motorisé du couvercle revienne en position de base (ouvert).

25 Entretien et maintenance



L'appareil est peut-être contaminé.



Retirer la prise de secteur avant de nettoyer.
Avant d'utiliser une procédure de nettoyage ou de décontamination autre que celle recommandée par le fabricant, l'utilisateur vérifiera auprès du fabricant que la procédure prévue n'endommage pas l'appareil.

- Ne pas nettoyer centrifuges, rotors et accessoires dans un lave-vaisselle.
- Seul le nettoyage manuel et une désinfection liquide sont autorisés.
- La température de l'eau doit être située entre 20 et 25°C.
- Utiliser exclusivement des agents de nettoyage ou de désinfection qui :
 - ont un pH de 5 à 8,
 - ne contiennent pas de substances caustiques, de peroxyde, composés chlorés, acides ni alcalins.
- Respecter impérativement les consignes spéciales d'utilisation données par le fabricant des agents de nettoyage et de désinfection, afin de prévenir la corrosion par les agents de nettoyage et de désinfection.

25.1 Centrifugeuse (boîtier, couvercle et cuve)

25.1.1 Entretien et nettoyage des surfaces

- Nettoyer régulièrement le boîtier de la centrifugeuse et le compartiment de centrifugation et les laver en cas de besoin avec du savon ou un détergent doux et un chiffon humide. Ces opérations sont nécessaires pour garantir l'hygiène et pour prévenir la corrosion par la présence durable d'impuretés.
- Substances des nettoyants adéquats :
savon, agents anioniques et non ioniques.
- Après utilisation des nettoyants, enlevez les résidus en essuyant l'appareil avec un chiffon humide.
- Séchez immédiatement les surfaces après nettoyage.
- Sécher le bol avec un chiffon absorbant en cas de dépôt d'eau de condensation dans le bol de la centrifugeuse.
- Frotter légèrement le joint d'étanchéité en caoutchouc du compartiment de centrifugation, après chaque nettoyage, avec de la poudre de talc ou un produit d'entretien pour caoutchouc.
- Vérifiez tous les ans le bon état de la cuve.



N'utilisez plus la centrifugeuse si elle présente des dommages susceptibles de porter atteinte à la sécurité.
Auquel cas, contactez le service après-vente.

25.1.2 Désinfection des surfaces

- Le bol de la centrifugeuse doit être nettoyé immédiatement dans le cas où un matériau infectieux a pénétré dans le bol de la centrifugeuse.
- Substances des désinfectants adéquats :
éthanol, n-propanol, isopropanol, glutardialdéhyde, combinaisons ammoniacales quaternaires.
- Après utilisation de désinfectants, enlevez les résidus en essuyant l'appareil avec un chiffon humide.
- Séchez immédiatement les surfaces après désinfection.

25.1.3 Décontamination de substances radioactives

- L'agent employé doit expressément convenir pour une décontamination de substances radioactives.
- Substances des agents adaptés à une décontamination des substances radioactives : agents anioniques, non ioniques agents, éthanol polyhydre.
- Après décontamination des substances radioactives, enlevez les résidus en essuyant l'appareil avec un chiffon humide.
- Séchez immédiatement les surfaces après décontamination des substances radioactives.

25.2 Rotors et accessoires

25.2.1 Nettoyage et entretien

- Afin de prévenir la corrosion et toute modification des matériaux, il faut nettoyer régulièrement les rotors et les accessoires avec du savon ou un détergent doux et un chiffon humide. Il est vivement recommandé d'effectuer un nettoyage au moins une fois par semaine. Enlevez immédiatement les impuretés.
- Substances des nettoyeurs adéquats : savon, agents anioniques et non ioniques.
- Après utilisation de nettoyeurs, enlevez les résidus en rinçant à l'eau claire (uniquement à l'extérieur de la centrifugeuse) ou en essuyant les surfaces avec un chiffon humide.
- Séchez rotors et accessoires immédiatement après nettoyage.
- Après séchage, les rotors d'angle, les réservoirs et la suspension en aluminium seront enduits d'une pellicule de graisse sans acide, par exemple la vaseline.
- Dans le cas des systèmes de sécurité biologique (Pour ce qui concerne les systèmes à sécurité biologique, voir le chapitre "Anhang/Appendix, Rotoren und Zubehör/Rotors and accessories") il faut contrôler et nettoyer les bagues d'étanchéité régulièrement (toutes les semaines). Changer immédiatement la bague d'étanchéité si elle présente des marques de fissuration, de friabilité et d'usure. Pour éviter de fausser la bague d'étanchéité en ouvrant et en fermant le couvercle, il faut frotter légèrement la bague d'étanchéité avec de la poudre de talc ou un produit d'entretien pour caoutchouc.
- Déposer le rotor au moins une fois par mois, nettoyer et enduire l'arbre d'entraînement d'une pellicule de graisse pour prévenir la corrosion par la présence d'humidité entre le rotor et l'arbre d'entraînement.
- Contrôler les rotors et les accessoires une fois par mois pour déceler d'éventuels symptômes d'usure ou des dégâts de corrosion.
Pour les rotors à oscillation, vérifier surtout la zone de portée des tourillons et pour les balanciers, vérifier les rainures et le fond pour détecter les éventuelles fissures.



Les rotors et les accessoires usés et endommagés par la corrosion ne doivent plus être utilisés.

- Vérifier chaque semaine la stabilité de fixation du rotor.

25.2.2 Désinfection

- Si les rotors ou accessoires sont infectés, procédez à une désinfection appropriée.
- Substances des désinfectants adéquats : glutaraldehyde, propanol, éthylènehexanol, agents anioniques, inhibiteurs de corrosion.
- Après utilisation de désinfectants, enlevez les résidus en rinçant à l'eau claire (uniquement à l'extérieur de la centrifugeuse) ou en essuyant les surfaces avec un chiffon humide.
- Séchez rotors et accessoires immédiatement après désinfection.

25.2.3 Décontamination de substances radioactives

- L'agent employé doit expressément convenir pour une décontamination de substances radioactives.
- Substances des agents adaptés à une décontamination des substances radioactives : agents anioniques, agents non ioniques, éthanol polyhydre.
- Après décontamination des substances radioactives, enlevez les résidus en rinçant à l'eau claire (uniquement à l'extérieur de la centrifugeuse) ou en essuyant les surfaces avec un chiffon humide.
- Séchez immédiatement rotors et accessoire après décontamination des substances radioactives.

25.2.4 Goupilles de fixation

Les goupilles de fixation des rotors à amortissement doivent être graissées régulièrement (graisse de lubrification Hettich n° 4051) de manière à assurer le balancement régulier de la suspension.

25.2.5 Rotors et accessoires à durée d'utilisation limitée

L'utilisation de certains rotors, balanciers et accessoires est limitée dans le temps.

Ces limites sont indiquées par le nombre maximum de cycles ou la date limite d'utilisation et le nombre maximum de cycles, ou simplement la date limite d'utilisation, par ex. :

- "einsetzbar bis Ende: IV. Quartal 2011 / usable until end of: IV. trimestre 2011" (utilisation autorisée jusqu'à fin: IV. trimestre 2011) ou
- "einsetzbar bis Ende Monat/Jahr: 10/2011 / usable until end of month/year: 10/2011" (utilisation autorisée jusqu'à fin mois/an : 10/2011)
- "max. Laufzyklen / max. cycles: 40000" (nombre ma. de cycles 40000)



Pour des raisons de sécurité, l'utilisation de rotors, balanciers et accessoires n'est plus autorisée dès que le nombre maximum de cycles désigné ou la date limite d'utilisation inscrite sont atteints.

25.3 Autoclavage

Les matériels suivants peuvent être autoclavés à 121° C / 250° F (20 min) :

- rotors à oscillation
- rotors angulaires en aluminium
- balanciers en métal
- couvercles à joint d'étanchéité biologique
- châssis
- réducteurs

En cas de doute, il faut se renseigner auprès du fabricant.

Le degré de stérilité ne peut pas être indiqué.



Avant l'autoclavage, déposer le couvercle des rotors et du récipient.

L'autoclavage provoque l'accélération du vieillissement des plastiques et peut provoquer des décolorations des plastiques.

Nous recommandons le remplacement des bagues d'étanchéité de bio systèmes de sécurité après autoclave.

25.4 Réservoirs de centrifugation

- En cas de fuite ou de rupture de récipients de centrifugation, il faut éliminer tous les morceaux de récipients cassés, les fragments de verre et les substances centrifugées écoulées.
- Les amortisseurs antivibrations ainsi que les caoutchouc intermédiaires des rotors doivent être remplacés après un bris de verre.



Les fragments de verre restants peuvent entraîner d'autres bris de verre !

- S'il s'agit d'un matériau infectieux, exécuter immédiatement une désinfection.

26 Défaits

Si l'erreur ne peut pas être éliminée d'après le tableau des défauts, il faut alors avertir le service après-vente.

Veuillez indiquer le type de centrifuge et le numéro de série. Les deux numéros sont indiqués sur la plaque signalétique de la centrifugeuse.

-  Effectuer une RÉINITIALISATION DU SECTEUR :
- Couper l'interrupteur de secteur (position de l'interrupteur "0").
 - Attendre au moins 10 secondes et refermer ensuite l'interrupteur de secteur (position de l'interrupteur "I").

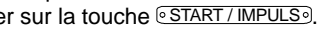
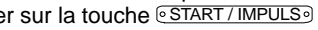
Message / Erreur		Origine	Solution	
Pas de message	---	Pas de tension Déclenchement du fusible protecteur contre surintensité.	<ul style="list-style-type: none"> - Contrôler la tension d'alimentation - Secteur en marche 	
TACHO - ERROR	1, 2, 96	Tachymètre défectueux. Défaut de l'électronique du moteur.	<ul style="list-style-type: none"> - Ouvrir le couvercle. - Couper l'interrupteur de secteur (position de l'interrupteur "0"). 	
CONTROL - ERROR	8	Erreur du verrouillage ou de la fermeture du capot.	<ul style="list-style-type: none"> - Attendre au moins 10 secondes. - Tourner vigoureusement le rotor à la main. - Refermer l'interrupteur de secteur (position de l'interrupteur "I"). Le rotor doit fonctionner pendant la mise en marche. 	
IMBALANCE	---	Le rotor est chargé de manière non symétrique.	<ul style="list-style-type: none"> - Ouvrir le capot. - Vérifier le chargement du rotor, voir au chapitre "Chargement du rotor". - Répéter le cycle de centrifugation. 	
CONTROL - ERROR	4, 6	Erreur du verrouillage ou de la fermeture du capot.	<ul style="list-style-type: none"> - Effectuer une RÉINITIALISATION DU SECTEUR. 	
N > MAX	5	Survitesse		
N < MIN	13	Vitesse trop basse		
MAINS INTERRUPT	---	Interruption du secteur pendant le cycle de centrifugation. (Le cycle de centrifugation n'est pas terminé.)	<ul style="list-style-type: none"> - Ouvrir le capot. - Appuyer sur la touche . - En cas de besoin, répéter le cycle de centrifugation. 	
ROTORCODE	10.1, 10.2	Erreur codage du rotor	<ul style="list-style-type: none"> - Ouvrir le capot. 	
CONTROL-ERROR	21, 22, 25, 27, 29	Défaut / Panne de l'électronique.	<ul style="list-style-type: none"> - Effectuer une RÉINITIALISATION DU SECTEUR. 	
CONTROL-ERROR	23	Défaut / Panne d'un organe de commande.		
SER I/O - ERROR	30, 31, 33, 36	Défaut / Panne de l'électronique.		
° C * - ERROR	51 - 53, 55	Défaut / Panne de l'électronique.		
FU / CCI - ERROR	60 - 64, 67, 68, 82 - 86	Défaut / Panne de l'électronique / du moteur.		
SYNC-ERROR	90	Défaut / Panne de l'électronique.		
SENSOR-ERROR	91 - 93	Fehler / Defekt Unwuchtsensor		
KEYBOARD-ERROR	---	Défaut / Panne d'un organe de commande.		
NO ROTOR	---	Pas de rotor intégré		<ul style="list-style-type: none"> - Ouvrir le capot. - Monter rotor.
N > ROTOR MAX	---	Vitesse de rotation paramétrée dans le programme sélectionné supérieure à la vitesse maximale de rotation du rotor.		<ul style="list-style-type: none"> - Vérifier la vitesse du programme sélectionnée - Corriger la vitesse du programme sélectionnée
		Le rotor a été remplacé. Le rotor actuellement en place a une vitesse de rotation maximale supérieure à celle du rotor utilisé précédemment et il n'a pas encore été identifié par l'identification du rotor.	<ul style="list-style-type: none"> - Paramétrer une vitesse de rotation inférieure ou égale à la vitesse de rotation maximale du rotor utilisé précédemment. Appuyer sur la touche  pour procéder à l'identification du rotor, voir chapitre "Identification du rotor". 	

27 Renvoi d'appareils au fabricant



Avant de renvoyer l'appareil, il faut monter le dispositif de fixation pour le transport.

Dans le cas où l'appareil ou ses accessoires doivent être retournés à la société Andreas Hettich GmbH & Co. KG, il faut les décontaminer et les nettoyer avant expédition, dans le but d'assurer la protection des personnes, de l'environnement et du matériel.

Nous nous réservons le droit de refuser des appareils ou des accessoires contaminés.

Nous facturons au client les frais de nettoyage et de désinfection.

Vous voudrez bien manifester votre compréhension pour cette réglementation.

28 Élimination des déchets

Avant de mettre l'appareil au rebut, vous devez le décontaminer et le nettoyer pour la protection des personnes, de l'environnement et du matériel.

Les dispositions légales en vigueur doivent être respectées lors de l'élimination de l'appareil.

Conformément à la directive 2002/96/CE (WEEE), tous les appareils livrés après le 13.08.2005 ne doivent plus être jetés avec les déchets ménagers. L'appareil fait partie du groupe 8 (dispositifs médicaux) et est classé dans le domaine "Business-to-Business".



Le symbole de la poubelle barrée d'une croix indique que l'appareil ne doit pas être jeté avec les déchets ménagers.

Les dispositions relatives à l'élimination des déchets des différents pays de l'UE peuvent varier. Veuillez-vous adresser en cas de besoin à votre fournisseur.

Indice

1	Usò previsto.....	74
2	Rischi residui	74
3	Dati tecnic.....	74
4	Indicazioni inerenti la sicurezza	77
5	Significato dei simboli	79
6	Contenuto della fornitura	79
7	Disimballo della centrifuga.....	79
8	Messa in funzione.....	80
9	Apertura e chiusura del coperchio	80
9.1	Apertura del coperchio	80
9.2	Chiusura del coperchio.....	80
10	Installazione e disinstallazione del rotore	81
11	Carico del rotore.....	81
12	Chiudere i sistemi biologici di sicurezza	82
13	Elementi di operazione e visualizzazione.....	82
13.1	Manopola	82
13.2	Tasti del display	82
13.3	Possibilità di regolazione	83
14	Inserire i parametri di centrifugazione	83
15	Programmazione	84
15.1	Inserimento/Variatione del programma	84
15.2	Richiamo del programma.....	84
16	Centrifugazione	84
16.1	Centrifugazione con tempo preimpostato	84
16.2	Corsa continua.....	85
16.3	Centrifugazione breve.....	85
17	Arresto di emergenza	85
18	Segnale acustico.....	85
19	Consultazione delle ore di funzionamento.....	85
20	Raffreddamento (solo per centrifuga con raffreddamento).....	86
20.1	Raffreddamento-Standby.....	86
20.2	Pre-raffreddamento del rotore.....	86
21	Accelerazione centrifuga relativa (RCF).....	86
22	Centrifugazione di sostanze o di miscele di sostanze con densità maggiore di 1,2 kg/dm ³	87
23	Riconoscimento del rotore.....	87
24	Sblocco di emergenza.....	87
25	Pulizia e manutenzione	88
25.1	Centrifughe (scatola, coperchio e vano di centrifugazione)	88
25.1.1	Cura e pulizia delle superfici	88
25.1.2	Disinfezione delle superfici	88
25.1.3	Rimuovere contaminazioni radioattive	88

25.2	Rotori ed accessori	89
25.2.1	Pulizia e cura	89
25.2.2	Disinfezione	89
25.2.3	Rimuovere contaminazioni radioattive	89
25.2.4	Perni di trascinamento	89
25.2.5	Rotori ed accessori con limitata durata di impiego.....	90
25.3	Mantenere in autoclave.....	90
25.4	Contenitori centrifuga	90
26	Guasti	91
27	Rispedizione di apparecchi.....	92
28	Smaltimento	92
29	Anhang / Appendix	93
29.1	Rotoren und Zubehör / Rotors and accessories.....	93

1 Uso previsto

Per quanto riguarda l'apparecchio in oggetto, si tratta di un prodotto medico (centrifuga di laboratorio) ai sensi della direttiva Diagnostici in vitro (IVD) 98/79/CE.

La centrifuga è stata concepita per separare materiali o miscele di materiali che hanno una densità massima di 1,2 kg/dm³. Fanno parte in particolare di questa classificazione i campioni per le preparazioni a scopi diagnostici In-vitro nella medicina umana.

Le centrifuga è destinata solo a questo scopo d'impiego.

Un diverso od ulteriore tipo di impiego non è regolamentare. La ditta Andreas Hettich GmbH & Co. KG non si prende carico di alcuna responsabilità nel caso di danni da ciò derivanti.

Per l'impiego a norma è previsto anche il rispetto di tutte le avvertenze riportate nelle istruzioni d'uso ed il rispetto degli interventi di ispezione e di manutenzione.

2 Rischi residui

L'apparecchio è costruito secondo lo stato attuale della tecnica e le regole riconosciute riguardanti la tecnica della sicurezza. In caso di uso ed impiego non regolamentari possono insorgere pericoli mortali per l'utilizzatore o per terzi risp. danni all'apparecchio o ad altri beni materiali. L'apparecchio è destinato solo all'uso regolamentare e va utilizzato solo in uno stato perfetto per quanto riguarda la tecnica della sicurezza.

Eventuali anomalie, che possono pregiudicare la sicurezza devono essere immediatamente eliminate.

3 Dati tecnici

Costruttore	Andreas Hettich GmbH & Co. KG D-78532 Tuttlingen			
Modello	UNIVERSAL 320		UNIVERSAL 320 R	
Tipo	1401	1401-01	1406	1406-01
Tensione di rete ($\pm 10\%$)	200-240 V 1~	100-127 V 1~	200-240 V 1~	240 V 1~ 115-127 V 1~
Frequenza di rete	50 – 60 Hz	50 – 60 Hz	50 Hz	60 Hz 60 Hz
Potenza assorbita	400 VA	400 VA	800 VA 950 VA	
Assorbimento di corrente	2.0 A	4.0 A	4.0 A	8.0 A
Tipo di refrigerante	----		R 404A	
Capacità max.	4 x 100 ml			
Densità permessa	1.2 kg/dm ³			
Regime di rotazione (RPM)	15000			
Accelerazione (RCF)	21382			
Energia cinetica	8600 Nm			
Obbligo di collaudo (BGR 500)	no			
Presupposti ambientali (EN / IEC 61010-1)	solo in interni			
– luogo di installazione	fino a 2000 metri sopra il livello del mare			
– altezza	2°C fino a 35°C 5°C fino a 35°C			
– temperatura ambiente	umidità relativa massima dell'aria 80% per temperature fino a 31°C, con riduzione lineare fino al 50% dell'umidità relativa per una temperatura di 40°C.			
– umidità dell'aria	II			
– Categoria di sovratensione (IEC 60364-4-443)	2			
– grado di imbrattamento	I			
Classe di protezione	I			
non adatto per l'impiego in ambiente a rischio di esplosione.				
Compatibilità elettromagnetica	EN / IEC 61326-1, classe B		EN / IEC 61326-1, classe B	
– emissione di radiointerferenze, resistenza alle interferenze	FCC Class B		FCC Class B	
Livello di emissione acustica (in funzione del rotore)	≤ 68 dB(A)		≤ 58 dB(A)	
dimensioni				
– larghezza	395 mm		401 mm	
– profondità	520 mm		695 mm	
– altezza	346 mm		346 mm	
Peso	ca. 31 kg		ca. 53 kg	ca. 52 kg

Costruttore	Andreas Hettich GmbH & Co. KG D-78532 Tuttlingen			
Modello	UNIVERSAL 320 R			
Tipo	1406-50	1406-51	1406-70	1406-71
Tensione di rete ($\pm 10\%$)	200-240 V 1~	100-127 V 1~	200-240 V 1~	100-127 V 1~
Frequenza di rete	50 – 60 Hz	50 – 60 Hz	50 – 60 Hz	50 – 60 Hz
Potenza assorbita	400 VA	400 VA	400 VA	400 VA
Assorbimento di corrente	2.0 A	4.0 A	2.0 A	4.0 A
Capacità max.	4 x 100 ml			
Densità permessa	1.2 kg/dm ³			
Regime di rotazione (RPM)	15000			
Accelerazione (RCF)	21382			
Energia cinetica	8600 Nm			
Obbligo di collaudo (BGR 500)	no			
Presupposti ambientali (EN / IEC 61010-1)	<p>solo in interni fino a 2000 metri sopra il livello del mare 2°C fino a 35°C umidità relativa massima dell'aria 80% per temperature fino a 31°C, con riduzione lineare fino al 50% dell'umidità relativa per una temperatura di 40°C.</p>			
– luogo di installazione				
– altezza				
– temperatura ambiente				
– umidità dell'aria	umidità relativa massima dell'aria 80% per temperature fino a 31°C, con riduzione lineare fino al 50% dell'umidità relativa per una temperatura di 40°C.			
– Categoria di sovratensione (IEC 60364-4-443)	II			
– grado di imbrattamento	2			
Classe di protezione	I			
non adatto per l'impiego in ambiente a rischio di esplosione.				
Compatibilità elettromagnetica				
– emissione di radiointerferenze, resistenza alle interferenze	EN / IEC 61326-1, classe B	FCC Class B	EN / IEC 61326-1, classe B	FCC Class B
Livello di emissione acustica (in funzione del rotore)	≤ 58 dB(A)			
dimensioni				
– larghezza	395 mm			
– profondità	520 mm			
– altezza	346 mm			
Peso	ca. 35 kg			

Costruttore	Andreas Hettich GmbH & Co. KG D-78532 Tuttlingen		
Modello	UNIVERSAL 320 R		
Tipo	1406-20		1406-21
Tensione di rete ($\pm 10\%$)	200-240 V 1~	240 V 1~	115-127 V 1~
Frequenza di rete	50 Hz	60 Hz	60 Hz
Potenza assorbita	800 VA		950VA
Assorbimento di corrente	4.0 A		8.0 A
Tipo di refrigerante	R 404A		
Capacità max.	4 x 100 ml		
Densità permessa	1.2 kg/dm ³		
Regime di rotazione (RPM)	15000		
Accelerazione (RCF)	21382		
Energia cinetica	8600 Nm		
Obbligo di collaudo (BGR 500)	no		
Presupposti ambientali (EN / IEC 61010-1)	<p>solo in interni fino a 2000 metri sopra il livello del mare 5°C fino a 35°C umidità relativa massima dell'aria 80% per temperature fino a 31°C, con riduzione lineare fino al 50% dell'umidità relativa per una temperatura di 40°C.</p>		
– luogo di installazione			
– altezza			
– temperatura ambiente			
– umidità dell'aria			
– Categoria di sovratensione (IEC 60364-4-443)	II		
– grado di imbrattamento	2		
Classe di protezione	I		
non adatto per l'impiego in ambiente a rischio di esplosione.			
Compatibilità elettromagnetica			
– emissione di radiointerferenze, resistenza alle interferenze	EN / IEC 61326-1, classe B	FCC Class B	
Livello di emissione acustica (in funzione del rotore)	≤ 58 dB(A)		
dimensioni			
– larghezza	401 mm		
– profondità	695 mm		
– altezza	346 mm		
Peso	ca. 52 kg		

4 Indicazioni inerenti la sicurezza



Se non vengono rispettate tutte le avvertenze riportate in queste istruzioni per il funzionamento, non può essere accettata da parte del costruttore alcuna richiesta di garanzia.



- **La centrifuga deve venire posizionata in modo sicuro.**
- **Prima di utilizzare la centrifuga, è necessario controllare che il rotore sia correttamente in sede.**
- **Durante un'operazione di centrifugazione, in una zona di sicurezza di 300 mm attorno alla centrifuga non deve sostare alcuna persona, materiali pericolosi ed oggetti, in conformità alle norme EN / IEC 61010-2-020.**
- **I rotori, le sospensioni e gli accessori che presentano forti segni di corrosione o danni meccanici, oppure la cui durata d'impiego è scaduta, non devono più essere utilizzati.**
- **Se il vano di centrifugazione presenta danni rilevanti per la sicurezza, la centrifuga non deve essere più messa in funzione.**
- **In rotori oscillanti, i perni di trascinamento devono essere lubrificati regolarmente (Grasso lubrificante Hettich no. d'ord. 4051) per consentire un'oscillazione equilibrata dei ganci.**
- **Nel caso di centrifughe senza regolazione termica, con temperature ambiente elevate e/o con frequente impiego dell'apparecchiatura può presentarsi un riscaldamento del vano di centrifugazione. Per questo motivo non può venire esclusa una modificazione del materiale di prova a causa alla temperatura.**

- **Prima di mettere in funzione la centrifuga si devono leggere ed osservare le istruzioni per l'uso. L'apparecchio può essere utilizzato solo da persone che abbiano letto e compreso le istruzioni d'uso.**
- Oltre alle istruzioni per l'uso, si devono osservare anche i regolamenti, relativi alla protezione antinfortunistica ed i regolamenti tecnici, riconosciuti in materia di sicurezza del lavoro. Le istruzioni per l'uso vanno completate dalle norme nazionali in vigore nel paese d'impiego, relative alla protezione antinfortunistica ed alla tutela ambientale.
- La centrifuga è costruita in base all'attuale livello tecnologico e le regole di sicurezza conosciute. La centrifuga può essere tuttavia fonte di pericolo per l'operatore o per terzi, se non viene utilizzata da personale appositamente addestrato o se viene utilizzata in modo improprio o non conforme alla destinazione.
- Durante l'esercizio bisogna evitare di muovere la centrifuga o di urtarvi contro.
- In caso di guasto, ovvero del ripristino d'emergenza, non si deve assolutamente toccare il rotore.
- Quando la centrifuga passa da un ambiente freddo in uno caldo, per evitare danni dovuti alla condensa, lasciar riscaldare la centrifuga per almeno 3 ore nell'ambiente caldo prima di collegarla alla rete, oppure portare la centrifuga a temperatura d'esercizio mettendola in funzione per 30 minuti nell'ambiente freddo.
- Devono essere utilizzati esclusivamente i rotori e gli accessori omologati per questa apparecchiatura (vedere capitolo "Anhang/Appendix, Rotoren und Zubehör/Rotors and accessories"). Prima di utilizzare contenitori di centrifugazione, che non sono elencati nel capitolo "Appendice/Appendix, Rotori ed accessori/Rotors and accessories", l'utente deve accertarsi presso il costruttore, che questi possano venire utilizzati.
- Il rotore della centrifuga può essere caricato solo in conformità al capitolo " Carico del rotore".
- In caso di centrifugazione con massimo numero di giri, la densità dei materiali o delle miscele di materiali non deve superare il valore di composizione di $1,2 \text{ kg/dm}^3$.
- Non è consentito l'uso di centrifughe non bilanciate in modo regolamentare.
- Non è permesso l'impiego della centrifuga in ambiente a pericolo di esplosione.
- E' proibito l'uso di una centrifuga con:
 - materiali infiammabili od esplosivi
 - materiali che possono reagire chimicamente tra loro con forte energia.
- Se vengono centrifugate sostanze pericolose o miscele di sostanze contaminate da micro organismi tossici, radioattivi o patogeni, l'utente dovrà prendere opportuni provvedimenti in materia. Si devono fondamentalmente utilizzare contenitori per centrifugazione con tappi a vite speciali per sostanze pericolose. Con materiali dei gruppi di rischio 3 e 4, oltre ai contenitori per centrifugazione chiudibili si deve impiegare un sistema di sicurezza biologico (vedi manuale "Laboratory Biosafety Manual" dell'Organizzazione mondiale per la salute).

In un sistema di sicurezza biologico una guarnizione biologica (anello di guarnizione) impedisce la fuoriuscita delle goccioline e degli aerosol.

Se la sospensione di un sistema di sicurezza biologico viene usata senza coperchio, la guarnizione ad anello deve essere rimossa dalla sospensione per evitare di danneggiarla durante il ciclo di centrifugazione. Le guarnizioni ad anello danneggiate non possono più essere utilizzate per la chiusura a tenuta del sistema di sicurezza biologico.

Senza l'impiego di un sistema di sicurezza biologico, una centrifuga non è microbiologicamente a tenuta in conformità alla norma EN / IEC 61010-2-020.

Per la chiusura dei sistemi biologici di sicurezza seguire le indicazioni al capitolo "Chiudere i sistemi biologici di sicurezza".

Per quanto riguarda i sistemi biologici di sicurezza fornibili, rimandiamo al capitolo "Anhang/Appendix, Rotoren und Zubehör/Rotors and accessories". Nel dubbio chiedere maggiori informazioni al produttore o importatore.

- Non è consentito il funzionamento della centrifuga con sostanze altamente corrosive che possono pregiudicare la resistenza meccanica dei rotori, delle sospensioni e degli accessori.
- Gli interventi di riparazione devono essere effettuati esclusivamente da una persona autorizzata dal costruttore.
- Devono essere impiegati solo ed esclusivamente pezzi di ricambio originali ed accessori autorizzati della ditta Andreas Hettich GmbH & Co. KG.
- Sono di validità le seguenti norme di sicurezza:
EN / IEC 61010-1 e EN / IEC 61010-2-020 come anche le loro nazionali varianti.
- La sicurezza e l'affidabilità della centrifuga sono garantite solo se:
 - la centrifuga funziona in conformità con le istruzioni per l'uso
 - l'installazione elettrica sul luogo di posizionamento della centrifuga risponde ai requisiti previsti dalla EN / IEC
 - i controlli previsti in base a BGV A1, BGR 500 vengono eseguiti da un perito esperto in materia.

5 Significato dei simboli



Simbolo sull'apparecchio:

Attenzione, punto pericoloso generico.

Prima di utilizzare l'apparecchiatura leggere in ogni caso le istruzioni per l'uso ed osservare le istruzioni rilevanti per la sicurezza!



Simbolo in questo documento.

Attenzione, punto pericoloso generico.

Questo simbolo contraddistingue le avvertenze relative alla sicurezza e indica situazioni potenzialmente pericolose .

La mancata osservanza di tali avvertenze può causare danni materiali e personali.



Simbolo sull'apparecchiatura ed in questo documento:

Attenzione: rischio biologico.



Simbolo in questo documento:

Questo simbolo indica argomenti importanti.



Simbolo sull'apparecchiatura ed in questo documento:

Simbolo per la raccolta separata delle apparecchiature elettriche ed elettroniche, in conformità alle direttive 2002/96/CEE (WEEE). L'apparecchiatura appartiene al gruppo 8 (apparecchiature medicali).

Impiego nelle nazioni dell'Unione Europea, in Norvegia ed in Svizzera.

6 Contenuto della fornitura

- 1 cavo elettrico
- 1 chiave a forcella
- 1 grasso per perni portanti
- 1 istruzioni per l'uso
- 1 istruzioni per la sicurezza durante il trasporto

Rotore/i e i corrispondenti accessori vengono forniti in base alla commessa.

7 Disimballo della centrifuga

- Levare il cartone verso l'alto e togliere l'imbottitura.

•



Non sollevarla dalla copertura anteriore.

Considerare il peso della centrifuga, vedere capitolo "Dati tecnici".

Con il numero adeguato di persone, sollevare la centrifuga da entrambi i lati e riporla sul tavolo di laboratorio.

8 Messa in funzione

- Secondo la norma sugli strumenti di laboratorio EN / IEC 61010-2-020 gli impianti domestici devono essere provvisti di apposito sezionatore d'emergenza per l'interruzione della rete in caso di guasto. L'interruttore deve essere posizionato distante dalla centrifuga, preferibilmente al di fuori della stanza in cui è posizionata la centrifuga o vicino all'uscita.
- Togliere la sicura per il trasporto, che si trova sul fondo dell'alloggiamento, vedere foglio avvisi "Sicura per il trasporto".
- Porre la centrifuga in un posto adatto e livellarla. Per l'installazione deve essere rispettata la zona di sicurezza di 300 mm attorno alla centrifuga, richiesta in conformità alle norme EN / IEC 61010-2-020.



Durante un'operazione di centrifugazione, in una zona di sicurezza di 300 mm attorno alla centrifuga non deve sostare alcuna persona, materiali pericolosi ed oggetti, in conformità alle norme EN / IEC 61010-2-020.

- Non posizionare alcun oggetto in prossimità delle griglie di ventilazione. Mantenere un'area di ventilazione di 300 mm, intorno al condotto.
- Con la centrifuga del tipo 1406-20, 1406-21, collegare l'alimentazione dell'azoto in conformità alla documentazione informativa AH1406-20XX allegata.
Con la centrifuga del tipo 1406-50, 1406-51, collegare il termostato per la ricircolazione basse temperature in conformità alla documentazione informativa AH1406-50XX allegata.
Con la centrifuga del tipo 1406-70, 1406-71, collegare il termostato per la ricircolazione basse temperature e l'alimentazione dell'azoto in conformità alla documentazione informativa AH1406-70XX allegata.



Il collegamento della centrifuga deve avvenire assolutamente in conformità con la documentazione informativa allegata.

Prestate attenzione al foglio informativo allegato.

- Verificare se la tensione di rete sia adatta all'indicazione riportata nella targhetta con i dati caratteristici.
- Collegare la centrifuga ad una spina standard di rete tramite il cavo di collegamento. Per la potenza massima assorbita, vedere il capitolo "Dati tecnici".
- Accendere l'interruttore di rete. Posizione di accensione "I".
Il tipo di macchina e la versione di programma vengono indicati, i LED sono illuminati. Dopo 8 secondi viene visualizzato OPEN OEFFNEN e lampeggia il LED di sinistra nel tasto STOP / OPEN .
- Aprire il coperchio.
I dati di centrifuga utilizzati per ultimi vengono illustrati.

9 Apertura e chiusura del coperchio

9.1 Apertura del coperchio



E' possibile aprire il coperchio solo se la centrifuga è accesa ed il rotore è fermo.
Se non dovesse essere possibile, vedi capitolo "Sblocco di emergenza".

- Premere il tasto OPEN / STOP . Il coperchio si sblocca a motore e il LED sinistro nel tasto OPEN / STOP si spegne.

9.2 Chiusura del coperchio



Non afferrare con le dita tra il coperchio e il rivestimento.
Non chiudere il coperchio sbattendolo.

Quando lampeggia il LED di sinistra nel tasto OPEN / STOP , premere il tasto OPEN / STOP , in modo che il bloccaggio motorico del coperchio prenda la posizione di base (aperto).

- Posizionare il coperchio e spingere leggermente verso il basso il bordo anteriore del coperchio. La chiusura avviene grazie ad un sistema motorizzato. Si illumina il LED sinistro del tasto OPEN / STOP .

10 Installazione e disinstallazione del rotore

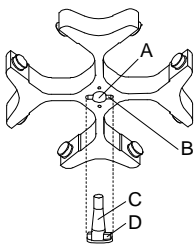

- Pulire l'albero motore (C) ed il foro del rotore (A), successivamente lubrificare leggermente l'albero motore. Particelle di sporco tra l'albero motore ed il rotore impediscono un normale funzionamento del rotore e causano un movimento rumoroso.
- Porre il rotore in senso verticale sull'albero motore. Il meccanismo di trascinamento dell'albero motore (D) deve trovarsi nella scanalatura del rotore (B). Sul rotore è segnato l'allineamento della scanalatura.
- Stringere il dado di registrazione di tensione del rotore con l'aiuto della chiave inclusa nel cartone, ruotandola in senso orario.
- Verificare che il rotore sia fissato.
- Disinstallare il rotore: svitare il dado di registrazione di tensione, ruotandolo in senso anti-orario fino a che non abbia raggiunto il punto di completo svitamento. Con il punto di svitamento completo, il rotore si può smontare dal cono dell'albero motore. Girare il dado di registrazione di tensione fino a che diventi possibile smontare il rotore dall'albero motore.

11 Carico del rotore



Lo standard dei recipienti di vetro centrifugati sono da caricare fino a RCF 4000 (DIN 58970 capoverso 2).

- Verificare che il rotore sia fissato.
- Nel caso di rotori oscillanti, tutti i siti del rotore devono essere muniti di ganci **uguali**. Particolari ganci sono contrassegnati con il numero del sito del rotore. Questi ganci devono essere applicati solo nel relativo sito del rotore.

Ganci contrassegnati con un numero di kit, p.es. S001/4, devono essere utilizzati esclusivamente in kit.

- I rotori ed i ganci devono essere caricati esclusivamente in modo simmetrico. I recipienti di centrifuga devono essere distribuiti uniformemente su tutti i posti del rotore. Per le combinazioni permesse vedere capitolo "Anhang/Appendix, Rotoren und Zubehör/Rotors and accessories".

In caso di rotori angolari devono essere caricati tutti i possibili siti del rotore, vedere il capitolo "Anhang/Appendix, Rotoren und Zubehör/Rotors and accessories".

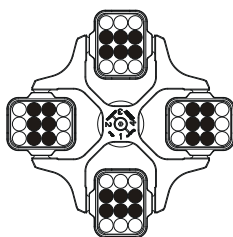

Il rotore è caricato uniformemente

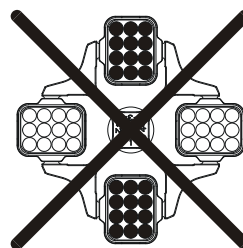

Non ammesso!

Il rotore è caricato in modo non uniforme

- Su certe sospensioni è indicato il peso del carico massimo oppure il peso del carico massimo e il peso massimo della sospensione completamente equipaggiata. Questi pesi non devono essere superati. In casi eccezionali vedere al capitolo "Centrifugazione di sostanze o di miscele di sostanze con densità maggiore di 1,2 kg/dm³". Il peso indicato per il carico massimo comprende il peso completo di riduttore, supporto, provetta da centrifuga e contenuto.
- Nel caso di contenitori con inserimenti in gomma, deve essere sempre mantenuto lo stesso numero di inserimenti in gomma sotto i contenitori di centrifugazione.
- Riempire i recipienti della centrifuga all'esterno della centrifuga stessa.
- Fare attenzione che non giunga alcuna sostanza liquida nella camera di centrifugazione durante il carico ed l'oscillazione dei ganci.
- Il carico massimo dei recipienti della centrifuga non deve essere superiore a quello indicato dalla casa costruttrice.
- Per limitare al massimo le differenze di peso all'interno dei contenitori di centrifugazione, bisogna fare attenzione che siano riempiti tutti in modo uguale.

12 Chiudere i sistemi biologici di sicurezza



Per garantire la tenuta, il coperchio di un sistema biologico di sicurezza deve essere ben chiuso.

Per evitare che durante l'apertura e la chiusura del coperchio l'anello di guarnizione si giri, spalmarvi, frizionando leggermente, polvere di talco o una sostanza per la cura della gomma.

Se la sospensione di un sistema di sicurezza biologico viene usata senza coperchio, la guarnizione ad anello deve essere rimossa dalla sospensione per evitare di danneggiarla durante il ciclo di centrifugazione. Le guarnizioni ad anello danneggiate non possono più essere utilizzate per la chiusura a tenuta del sistema di sicurezza biologico.

Per quanto riguarda i sistemi biologici di sicurezza fornibili, rimandiamo al capitolo "Anhang/Appendix, Rotoren und Zubehör/Rotors and accessories". Nel dubbio chiedere maggiori informazioni al produttore o importatore.

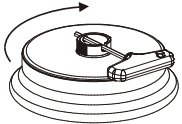

Coperchio con chiusura a vite e foro nella manopola:

- Inserire la chiave fornita attraverso il foro nella manopola e stringere ruotando il coperchio in senso orario.

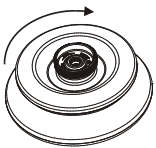

Coperchio con chiusura a vite senza foro nella manopola:

- Il coperchio deve essere chiuso manualmente, ruotandolo con forza in senso orario.

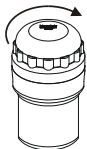

Coperchio con chiusura a vite:

- Il coperchio deve essere chiuso manualmente, ruotandolo con forza in senso orario.

13 Elementi di operazione e visualizzazione

Vedere illustrazione alla pagina 2

Fig. 2, Fig. 3: Display

13.1 Manopola



Per l'impostazione dei singoli parametri.

La rotazione in senso antiorario riduce il valore. La rotazione in senso orario aumenta il valore.

13.2 Tasti del display



- Tasto di selezione per selezionare i singoli parametri. Premendo successivamente questo tasto viene selezionato il parametro successivo.



- Avviare il ciclo di centrifuga. Il LED del tasto rimane acceso durante il ciclo di centrifuga, fintanto che il rotore gira.
- Centrifuga breve. Il ciclo di centrifuga continua fintanto che viene premuto il tasto. Il LED del tasto rimane acceso per tutto il ciclo, fintanto che il rotore gira.
- Salvare dati e modifiche.



- Terminare il ciclo di centrifuga. Il rotore si arresta con il livello di frenatura impostato. Il LED destro del tasto rimane acceso fintanto che il rotore non si arresta. Dopo l'arresto del rotore si illumina il LED sinistro del tasto. Premendo due volte il tasto si inserisce l'arresto d'emergenza.
- Sbloccare il coperchio. Si spegne il LED sinistro del tasto.
- Interrompere l'inserimento parametri.



- Commutare tra visualizzazione RPM e RCF. I valori RCF vengono visualizzati in > <.



- Avviare pre-riscaldamento. La velocità di pre-riscaldamento è regolabile. È preimpostata a 2800 giri/min.

13.3 Possibilità di regolazione

PROG RCL Posizione programma da richiamare.

t/min Durata ciclo. Impostabile da 0 - 99 min, ad intervalli di 1 min.

t/sec Durata ciclo. Impostabile da 0 - 59 sec., ad intervalli di 1 secondo .

Funzionamento continuo "∞". Azzerare i parametri **t/min** e **t/sec**.

RPM Numero di giri. È impostabile un valore numerico di 500 rpm fino al numero di giri massimo del rotore. Per il numero di giri massimo del rotore, vedi capitolo "Anhang/Appendix, Rotoren und Zubehör/Rotors and accessories". Impostabile ad intervalli di 10.

RAD/mm Raggio di centrifugazione. Inserimento in mm. Per il raggio di centrifugazione, vedere capitolo "Anhang/Appendix, Rotoren und Zubehör/Rotors and accessories". E' possibile digitare il raggio solo se viene selezionato l'indicatore RCF (> RCF <).

RCF Acceleramento relativo della centrifuga. È impostabile un valore numerico con il quale si ottiene un numero di giri compreso tra 500 rpm ed il numero di giri massimo del rotore. Regolabile fino a 100 in passi da 1 e da 100 in passi da 10 . Il valore RCF viene automaticamente arrotondato per eccesso o per difetto al passo del numero di giri. E' possibile digitare il RCF se viene selezionato l'indicatore RCF (> RCF <).



Livelli di inizio 1 - 9. Livello 9 = tempo di avvio più breve, livello 1 = tempo di avvio più lungo



Livelli di frenatura 0 - 9. Livello 9 = tempo di arresto più breve, livello 1 = tempo di arresto più lungo
Livello 0 = tempo di arresto più lungo (arresto non frenato).

T/°C Valore nominale di temperatura (solo per centrifuga con raffreddamento). Regolabile da -20°C fino a +40°C, in passi da 1°C. La temperatura minima raggiungibile dipende dal rotore (vedere capitolo "Anhang/Appendix, Rotoren und Zubehör/Rotors and accessories").

PROG STO Posizione in cui è memorizzato il programma. Si possono salvare 9 programmi (posizioni programmi 1 - 2 - 3 - ... 9). La posizione di memoria programma # funge da memoria transitoria per impostazioni modificate.

14 Inserire i parametri di centrifugazione



Nel caso in cui, dopo aver selezionato oppure durante l'inserimento di parametri, non venga premuto per 8 secondi alcun tasto, vengono indicati i valori precedenti. L'inserimento dei parametri deve essere poi eseguita nuovamente.

- Selezionare con il tasto **[RCF]** le indicazioni RPM oppure RCF. I valori RCF vengono visualizzati in > <.
- Selezionare i parametri richiesti con il tasto **[SELECT]** ed impostarli con la manopola **○**. Per impostare il funzionamento continuo, i parametri **t/min** e **t/sec** devono essere azzerati con la manopola **○**. Il funzionamento continuo è indicato sul display dal simbolo "∞".
- Dopo l'inserimento di tutti i parametri, premere il tasto **[START/IMPULS]** per salvare gli inserimenti nella memoria di programma # . Per conferma, viene indicata per alcuni secondi la dicitura ***** ok ***** .



I dati sulla posizione di memoria programma # vengono soprascritti con ogni nuovo inserimento di parametri e premendo il tasto **[START/IMPULS]**.

15 Programmazione

15.1 Inserimento/Variazione del programma



Nel caso in cui, dopo aver selezionato oppure durante l'inserimento di parametri, non venga premuto per 8 secondi alcun tasto, vengono indicati i valori precedenti. L'inserimento dei parametri deve essere poi eseguita nuovamente.

- Selezionare con il tasto **[RCF]** le indicazioni RPM oppure RCF. I valori RCF vengono visualizzati in **> <**.
- Selezionare i parametri richiesti con il tasto **[SELECT]** ed impostarli con la manopola **○**. Per impostare il funzionamento continuo, i parametri **t/min** e **t/sec** devono essere azzerati con la manopola **○**. Il funzionamento continuo è indicato sul display dal simbolo "∞".
- Selezionare il parametro **PROG STO** con il tasto **[SELECT]** ed impostare la posizione richiesta del programma con la manopola **○**.
- Premere il tasto **[START/IMPULS]** per salvare le impostazioni nel programma desiderato. A conferma viene visualizzato per breve tempo ***** ok *****.
Se viene premuto il tasto **[START/IMPULS]**, senza che sia stato selezionato il parametro **PROG STO**, le informazioni vengono memorizzate sempre sul posto di programma #.



I precedenti dati del programma vengono soprascritti con il salvataggio.

15.2 Richiamo del programma

- Selezionare con il tasto **[SELECT]** il parametro **PROG RCL** ed impostare il programma desiderato con la manopola **○**.
- Premere il tasto **[START/IMPULS]**. Vengono visualizzati i dati di centrifuga del programma selezionato.
- E' possibile verificare i parametri premendo il tasto **[SELECT]**.
Per uscire dalla visualizzazione dei parametri, premere il tasto **[OPEN/STOP]** oppure non premere alcun tasto per 8 secondi.

16 Centrifugazione



Durante un'operazione di centrifugazione, in una zona di sicurezza di 300 mm attorno alla centrifuga non deve sostare alcuna persona, materiali pericolosi ed oggetti, in conformità alle norme EN / IEC 61010-2-020.



Nel caso in cui la differenza di peso permissibile nel caricamento del rotore venga superata, si ferma l'azionamento durante l'avvio, si illumina l'indicazione di squilibrio e compare la dicitura **IMBALANCE**.

Una corsa di centrifugazione può essere interrotta in ogni momento premendo il tasto **[OPEN/STOP]**

Durante la corsa di centrifugazione, può essere selezionato e modificato ogni tipo di parametro (vedere capitolo "Inserire i parametri di centrifugazione").

Con il tasto **[RCF]** è possibile commutare in ogni momento le indicazioni RPM e RCF. Se viene usata l'indicazione RCF, è necessario inserire il raggio di centrifugazione.

Se compaiono le diciture **⚡ OPEN ⚡ OEFFNEN (=APRIRE)**, è possibile un'operazione della centrifuga solo dopo aver aperto una volta il coperchio.

Se viene visualizzato **R xx n-max xxxxx**, non ha avuto luogo alcun processo di centrifugazione in quanto è stato sostituito il rotore, vedere il capitolo "Riconoscimento del rotore".

- Accendere l'interruttore di rete. Posizione di accensione I.
- Caricare il rotore e chiudere il coperchio della centrifuga.

16.1 Centrifugazione con tempo preimpostato

- Selezionare il tempo oppure richiamare un programma con tempo preimpostato (vedere capitolo "Programmazione").
- Premere il tasto **[START/IMPULS]**. Il LED del tasto **[START/IMPULS]** rimane acceso fintanto che il rotore gira.
- Passato il tempo o con l'interruzione della corsa di centrifugazione premendo il tasto **[OPEN/STOP]**, avviene l'arresto con il livello di frenatura selezionato. Il livello di frenatura viene indicato..

Durante la corsa di centrifugazione compaiono il numero di giri del rotore, il valore RCF risultante, la temperatura delle provette (solo per centrifuga con raffreddamento) ed il tempo rimanente.

16.2 Corsa continua

- Impostazione il simbolo ∞ oppure richiamare il programma di corsa continua (vedere capitolo "Programmazione").
- Premere il tasto **START/IMPULS**. Il LED del tasto **START/IMPULS** rimane acceso fintanto che il rotore gira. Il conteggio del tempo inizia da 00:00.
- Premere il tasto **OPEN/STOP** per terminare la centrifugazione. L'arresto avviene con il livello di frenatura selezionato. Il livello di frenatura viene indicato.

Durante la centrifugazione compaiono il numero di giri del rotore, il valore RCF risultante, la temperatura delle provette (solo per centrifuga con raffreddamento) ed il tempo intercorso.

16.3 Centrifugazione breve

- Tenere premuto il tasto **START/IMPULS**. Il LED del tasto **START/IMPULS** rimane acceso fintanto che il rotore gira. Il conteggio del tempo inizia da 00:00.
- Togliere il dito dal tasto **START/IMPULS** per terminare la corsa di centrifugazione. L'arresto avviene con il livello di frenatura selezionato. Il livello di frenatura viene indicato.

Durante la centrifugazione compaiono il numero di giri del rotore, il valore RCF risultante, la temperatura delle provette (solo per centrifuga con raffreddamento) ed il tempo rimanente.

17 Arresto di emergenza

- Premere 2 volte il tasto **OPEN/STOP**

Con l'arresto di emergenza l'arresto avviene con il livello di frenatura 9 (arresto più breve). Il livello di frenatura 9 viene indicato.

Con il livello di frenatura preimpostato sullo 0, il tempo di arresto, per motivi tecnici, è superiore a quello raggiunto con il livello di frenatura 9.

18 Segnale acustico

Il segnale acustico si attiva quando:

- con il verificarsi di un guasto con intervallo di 2 sec
- dopo il terminare della corsa di centrifugazione e arresto del rotore con intervallo di 30 secondi

Aperto il coperchio oppure premendo un tasto qualsiasi, il segnale acustico cessa.

Il segnale che si attiva in seguito alla cessazione della corsa di centrifugazione, può essere attivato o disattivato, raggiunto l'arresto del rotore, in modo seguente:

- Tenere premuto il tasto **SELECT** per 8 secondi.
Dopo 8 sec. compare la dicitura **SOUND / BELL**.
- Impostare OFF (disinserito) o ON (inserito) con la manopola.
- Premere il tasto **START/IMPULS** per salvare le impostazioni. Per conferma, compare per alcuni secondi la dicitura ***** ok *****.

19 Consultazione delle ore di funzionamento

La consultazione delle ore di funzionamento è possibile solo con rotore in posizione di arresto.

- Tenere premuto il tasto **SELECT** per 8 secondi.
Dopo 8 sec. Compare la dicitura **SOUND / BELL**.
- Premere nuovamente il tasto **SELECT**
Compaiono le ore di funzionamento della centrifuga (CONTROL:).
- Per uscire dalla richiesta delle ore di funzionamento premere il tasto **OPEN/STOP**.

20 Raffreddamento (solo per centrifuga con raffreddamento)

Il valore nominale di temperatura può essere selezionata da -20°C fino a +40°C. La temperatura minima raggiungibile dipende dal rotore (vedere capitolo "Anhang/Appendix, Rotoren und Zubehör/Rotors and accessories").

20.1 Raffreddamento-Standby

Con l'arresto del rotore e coperchio chiuso, la camera di centrifugazione viene raffreddata alla temperatura selezionata. Nel display compare il valore nominale di temperatura.

Dopo un procedimento di centrifugazione, il raffreddamento-Standby avviene con un ritardo di tempo, e nel display compare **OPEN / OEFFNEN (aprire)**. Il ritardo di tempo è da 1 fino a 5 minuti, regolabile in passi di 1 minuto. Il ritardo è impostato di standard sul valore di 1 minuto.

A rotore fermo e coperchio aperto, il ritardo di tempo può essere impostato come segue.

- Tenere premuto il tasto **☒** per 8 secondi.
Dopo 8 secondi Compare la dicitura **t/min = X**.
- Impostare il ritardo di tempo con la manopola **○**.
- Premere il tasto **START/IMPULS** per salvare le impostazioni. Per conferma, compare per alcuni secondi la dicitura ***** ok *****.

Per abbandonare l'indicazione del ritardo tempo premere il tasto **OPEN/STOP** o non premere alcun tasto per il tempo di 8 secondi.

20.2 Pre-raffreddamento del rotore

- Premere il tasto **☒**. Il LED del tasto **START/IMPULS** rimane acceso fintanto che il rotore gira.
- Premere il tasto **OPEN/STOP** per terminare il pre-raffreddamento. L'arresto avviene con il livello di frenatura selezionato. Il livello di frenatura viene indicato.

Durante la centrifugazione compaiono il numero di giri del rotore, il valore RCF risultante, la temperatura delle provette ed il tempo intercorso.

La velocità di pre-raffreddamento è di 500 RPM (giri/min) ed è regolabile in passi da 10 fino al valore massimo del regime di rotazione del rotore. È preimpostata a 2800 giri/min.

A rotore fermo e a coperchio aperto è possibile impostare la velocità di pre-raffreddamento nel seguente modo:

- Tenere premuto il tasto **☒** per 8 secondi.
Dopo 8 secondi Compare la dicitura **t/min = X**.
- Premere nuovamente il tasto **☒**.
La velocità di pre-raffreddamento impostata **RPM = XXXX** viene indicata.
- Impostare la velocità di pre-raffreddamento desiderata con la manopola **○**.
- Premere il tasto **START/IMPULS** per salvare le impostazioni. Per conferma, compare per alcuni secondi la dicitura ***** ok *****.

Per abbandonare l'indicazione della velocità di pre-raffreddamento premere il tasto **OPEN/STOP** o non premere alcun tasto per il tempo di 8 secondi.

21 Accelerazione centrifuga relativa (RCF)

L'accelerazione centrifuga relativa (RCF) è indicata come un multiplo dell'accelerazione terrestre (g). È un valore numerico privo di unità e funge per paragonare le prestazioni di separazione e sedimentazione.

Il calcolo viene eseguito in base alla formula:

$$RCF = \left(\frac{RPM}{1000} \right)^2 \times r \times 1,118 \quad \Rightarrow \quad RPM = \sqrt{\frac{RCF}{r \times 1,118}} \times 1000$$

RCF = accelerazione centrifuga relativa

RPM = numero dei giri

r = raggio di centrifugazione in mm = distanza dal centro dell'asse di rotazione fino al fondo del recipiente di centrifugazione. Raggio di centrifugazione vedi al capitolo "Anhang/Appendix, Rotoren und Zubehör/Rotors and accessories".



L'accelerazione centrifuga relativa (RCF) dipende dal numero dei giri e dal raggio di centrifugazione.

22 Centrifugazione di sostanze o di miscele di sostanze con densità maggiore di 1,2 kg/dm³

In caso di centrifugazione con massimo numero di giri, la densità dei materiali o delle miscele di materiali non deve superare il valore di composizione di 1,2 kg/dm³.

Con sostanze o miscele di sostanze di densità maggiore, il regime di rotazione deve venire ridotto.

Il numero di giri consentito si calcola con la formula seguente:

$$\text{numero di giri ridotto (n}_{\text{red}}) = \sqrt{\frac{1,2}{\text{densità maggiore [kg/dm}^3]}} \times \text{regime massimo di rotazione [RPM]}$$

p.es.: regime massimo di rotazione RPM 4000, densità 1,6 kg/dm³

$$n_{\text{red}} = \sqrt{\frac{1,2 \text{ kg/dm}^3}{1,6 \text{ kg/dm}^3}} \times 4000 \text{ RPM} = 3464 \text{ RPM}$$

Se in casi eccezionali viene superato il carico massimo indicato sul gancio, il regime di rotazione deve essere ridotto.

Il numero di giri consentito si calcola con la formula seguente:

$$\text{numero di giri ridotto (n}_{\text{red}}) = \sqrt{\frac{\text{carico massimo [g]}}{\text{carico effettivo [g]}}} \times \text{regime massimo di rotazione [RPM]}$$

p.es.: regime massimo di rotazione RPM 4000, carico massimo 350 g, carico effettivo 300 g

$$n_{\text{red}} = \sqrt{\frac{300 \text{ g}}{350 \text{ g}}} \times 4000 \text{ RPM} = 3703 \text{ RPM}$$

In caso di dubbio, rivolgersi al costruttore per maggiori informazioni.

23 Riconoscimento del rotore

Con l'inizio di ogni corsa di centrifugazione avviene il riconoscimento del rotore installato.

Dopo una sostituzione del rotore, il ciclo di centrifugazione si interrompe dopo il riconoscimento del rotore. Vengono visualizzati il Rotorcode (R xx) e il numero di giri massimo (n-max=xxxxx) del rotore.



L'ulteriore utilizzo della centrifuga è possibile solo dopo avere aperto una volta il coperchio.

Se il numero di giri massimo del rotore utilizzato è inferiore al numero di giri impostato, la velocità viene limitata al numero di giri massimo del rotore.

24 Sblocco di emergenza

In caso di una caduta di tensione, il coperchio non può essere sbloccato a motore. Deve essere effettuata manualmente uno sblocco di emergenza.



Per lo sblocco di emergenza, disconnettere la centrifuga dalla rete elettrica.
Aprire il coperchio solo con l'arresto del rotore.

Vedere illustrazione alla pagina 2.

- Disinserire l'interruttore di rete (posizione interruttore "0").
- Guardare attraverso la finestra presente nel coperchio per assicurarsi che il rotore sia fermo.
- Introdurre la chiave per viti Allen nel foro (Fig. 1, A) e ruotarla con cautela di mezzo giro in senso orario, fino ad aprire il coperchio.
- Strappare la vite senza testa esagonale dal foro.
- Quando dopo il reinserimento della centrifuga lampeggia il LED di sinistra nel tasto **OPEN/STOP**, premere il tasto **OPEN/STOP** in modo che il bloccaggio motorico del coperchio prenda la posizione di base (aperto).

25 Pulizia e manutenzione



L'apparecchiatura può essere contaminata.



Prima della pulizia, staccare la presa di corrente.

Prima di iniziare un procedimento di pulizia e decontaminazione diverso da quello consigliato dal produttore, l'utilizzatore deve accertarsi presso il produttore che tale procedimento previsto non rechi danno all'apparecchio.

- Centrifughe, rotori e accessori non devono essere lavati in lavastoviglie.
- Si deve eseguire solo una pulizia manuale ed una disinfezione con liquido.
- La temperatura dell'acqua deve essere di 20 – 25°C.
- Devono essere utilizzati solo detersivi o disinfettanti che:
 - abbiano un campo di valori del pH che va da 5 a 8,
 - non contengano alcali caustici, perossidi, composti di cloro, acidi e soluzioni alcaline.
- Seguire attentamente le indicazioni speciali del produttore sull'impiego di detersivi e disinfettanti, al fine di evitare qualsiasi fenomeno di corrosione.

25.1 Centrifughe (scatola, coperchio e vano di centrifugazione)

25.1.1 Cura e pulizia delle superfici

- Pulire regolarmente il corpo della centrifuga e la camera di centrifugazione e impiegare all'occorrenza sapone o un detersivo delicato e un panno umido. Ciò serve da un lato per l'igiene e dall'altro lato per evitare la corrosione causata da impurità incrostate.
- Ingredienti dei detersivi adatti:
sapone, tensidi anionici, tensidi non ionici.
- Dopo l'impiego di detersivi, rimuovere i resti del detersivo pulendo di nuovo con un panno umido.
- Le superfici devono essere asciugate subito dopo la pulizia.
- In caso di formazione di acqua di condensa, asciugare la camera di centrifugazione pulendola con un panno assorbente.
- Spalmare sulla guarnizione di gomma della camera di centrifugazione, frizionando leggermente, polvere di talco o una sostanza per la cura della gomma.
- Controllare una volta l'anno se il vano di centrifugazione presenta danneggiamenti.



Se vengono stabiliti danni rilevanti per la sicurezza, la centrifuga non deve essere più messa in funzione. In questo caso si deve contattare il servizio assistenza clienti.

25.1.2 Disinfezione delle superfici

- In presenza di materiale infettivo nella camera di centrifugazione si deve disinfettarla immediatamente.
- Ingredienti dei disinfettanti adatti:
etanolo, alcol n proclitico, isopropanolo, glutaraldeide, composti di ammonio quaternario.
- Dopo l'impiego di disinfettanti, rimuovere i resti del disinfettante pulendo di nuovo con un panno umido.
- Le superfici devono essere asciugate subito dopo la disinfezione.

25.1.3 Rimuovere contaminazioni radioattive

- La sostanza deve essere certificata in modo speciale per rimuovere contaminazioni radioattive.
- Ingredienti di sostanze adatte alla rimozione di contaminazioni radioattive:
tensidi anionici, tensidi non ionici, etanolo poliidratato.
- Dopo aver rimosso le contaminazioni radioattive, rimuovere i resti della sostanza pulendo di nuovo con un panno umido.
- Le superfici devono essere asciugate, subito dopo la rimozione delle contaminazioni radioattive.

25.2 Rotori ed accessori

25.2.1 Pulizia e cura

- Per prevenire corrosione e alterazioni dei materiali, i rotori e l'accessorio devono essere regolarmente puliti con sapone o con un detergente delicato e con un panno umido. Si consiglia la pulizia almeno una volta la settimana. La sporcizia deve essere subito rimossa.
- Ingredienti dei detergenti adatti:
sapone, tensidi anionici, tensidi non ionici.
- Dopo l'impiego di detergenti, rimuovere i resti del detergente, risciacquando con acqua (solo al di fuori della centrifuga) o ripulendo con un panno umido.
- I rotori e gli accessori devono essere asciugati immediatamente dopo la pulizia.
- I rotor ad angolo, i contenitori e i supporti in alluminio devono essere ingrassati leggermente con grasso privo d'acidi come ad esempio vaselina quando sono ben asciutti.
- Nei sistemi di sicurezza biologici (Per quanto riguarda i sistemi biologici di sicurezza fornibili, rimandiamo al capitolo "Anhang/Appendix, Rotoren und Zubehör/Rotors and accessories") gli anelli di guarnizione devono essere controllati e puliti periodicamente (ogni settimana). In presenza di crepe, parti fragili o logorio, l'anello di tenuta deve essere subito sostituito. Per evitare che durante l'apertura e la chiusura del coperchio l'anello di guarnizione si giri, spalmarvi, frizionando leggermente, polvere di talco o una sostanza per la cura della gomma.
- Per evitare la corrosione causata dall'umidità tra il rotore e l'albero motore, si deve provvedere almeno una volta al mese di smontare il rotore, pulirlo e di lubrificare leggermente l'albero motore.
- I rotor e l'accessorio devono essere controllati una volta al mese per verificare che non vi siano usura o danni da corrosione.
Con i motori di smorzamento devono essere verificati soprattutto il settore dei perni di supporto e per i ganci le scanalature, verificare inoltre l'eventuale presenza di incrinature nel fondo.



Rotori ed accessori non devono essere più utilizzati se presentano consumo o corrosione.

- Verificare settimanalmente la posizione del rotore.

25.2.2 Disinfezione

- Se del materiale infetto viene a contatto con i rotor o con gli accessori, allora si deve eseguire una disinfezione adeguata.
- Ingredienti dei disinfettanti adatti:
glutaraldeide, propanolo, etilexanolo, tensidi anionici, inibitori di corrosione.
- Dopo l'impiego di disinfettanti, rimuovere i resti del disinfettante, risciacquando con acqua (solo al di fuori della centrifuga) o ripulendo con un panno umido.
- I rotor e gli accessori devono essere asciugati immediatamente dopo la disinfezione.

25.2.3 Rimuovere contaminazioni radioattive

- La sostanza deve essere certificata in special modo per rimuovere contaminazioni radioattive.
- Ingredienti di sostanze adatte alla rimozione di contaminazioni radioattive:
tensidi anionici, tensidi non ionici, etanolo poliidrato.
- Dopo la rimozione delle contaminazioni radioattive, rimuovere la sostanza, risciacquando con acqua (solo al di fuori della centrifuga) o ripulendo con un panno umido.
- I rotor e gli accessori devono essere asciugati subito dopo la rimozione delle contaminazioni radioattive.

25.2.4 Perna di trascinarsi

In rotor oscillanti, i perni di trascinarsi devono essere lubrificati regolarmente (Grasso lubrificante Hettich no. d'ord. 4051) per consentire un'oscillazione equilibrata dei ganci.

25.2.5 Rotori ed accessori con limitata durata di impiego

L'impiego di particolari rotor, ganci ed elementi accessori è limitato nel tempo.

Questi sono contrassegnati con la quantità max. di cicli di funzionamento o dalla data di scadenza ed il numero massimo di cicli di funzionamento o solo con la data di scadenza, p.es.:

- "einsetzbar bis Ende: IV. Quartal 2011 / usable until end of: IV. trimestre 2011" (utilizzabile fino alla fine: IV. trimestre 2011) o
"einsetzbar bis Ende Monat/Jahr: 10/201 / usable until end of month/year: 10/2011" (utilizzabile fino a fine mese/anno: 10/2011)
- "max. Laufzyklen / max. cycles: 40000". (Max. funzionamento cicli)



Per motivi di sicurezza l'impiego dei rotor, dei ganci e degli elementi di accessorio non è più ammesso, quando è raggiunta la quantità massima permessa dei cicli di funzionamento che è sopracontrassegnata o quando è raggiunta la data di scadenza sopracontrassegnata.

25.3 Mantenere in autoclave

Il seguente accessorio può essere sterilizzato in autoclave a 121°C / 250°F (20 min):

- Rotori basculanti
- Rotori angolari di alluminio
- Sospensioni in metallo
- Coperchio con chiusura ermetica anti-contaminazione
- Telaio
- Riduzioni

In caso di dubbio occorre informarsi presso la casa produttrice.

Non è possibile fare nessuna dichiarazione sul grado di sterilizzazione.



Il coperchio del rotore ed il contenitore devono essere staccati prima di essere riposti in autoclave.

La conservazione in autoclave accelera il processo di invecchiamento del materiale in plastica. Inoltre può causare variazioni di colore nel materiale in plastica.

Dopo il trattamento in autoclave consigliamo di sostituire le guarnizioni ad anello dei sistemi biologici di sicurezza.

25.4 Contenitori centrifuga

- In caso di mancanza di tenuta o dopo la rottura dei contenitori per centrifugazione, rimuovere completamente i frammenti dei contenitori, le schegge di vetro e il centrifugato fuoriuscito.
- Dopo la rottura di parti in vetro, sostituire gli inserti di gomma e i manicotti di plastica dei rotor.



Le schegge di vetro rimaste causano ulteriori rotture!

- Nel caso di materiale infettivo, bisogna provvedere immediatamente ad una disinfezione.

26 Guasti

Se non si riesce a eliminare l'errore seguendo le indicazioni della tabella guasti, informare il servizio assistenza clienti.

Si prega di indicare il tipo di centrifuga e il numero di serie. Entrambi i numeri sono visibili sulla targhetta di modello della centrifuga.

	<p>Esecuzione di un RESET RETE:</p> <ul style="list-style-type: none"> - Disinserire l'interruttore di rete (posizione interruttore "0"). - Attendere almeno 10 secondi quindi reinserire l'interruttore di rete (posizione interruttore "1").
---	--

Visualizzazione/guasto		Causa	Eliminazione
Nessuna visualizzazione	---	Non c'è tensione. Scatto fusibile sovraccorrente	<ul style="list-style-type: none"> - Controllare alimentatore elettrico. - Interruttore di rete ON.
TACHO - ERROR	1, 2, 96	Tachimetro difettoso. Motore, sistema elettronico difettoso.	<ul style="list-style-type: none"> - Aprire il coperchio. - Disinserire l'interruttore di rete (posizione interruttore "0"). - Attendere per almeno 10 secondi. - Girare energicamente a mano il rotore. - Reinserrire l'interruttore di rete (posizione interruttore "1"). Durante l'inserimento il rotore deve girare.
CONTROL - ERROR	8	Errore blocco coperchio, ovvero chiusura coperchio.	<ul style="list-style-type: none"> - Aprire il coperchio. - Controllare il caricamento del rotore, vedere il capitolo "Carico del rotore". - Ripetere il ciclo di centrifugazione.
IMBALANCE	---	Il rotore è caricato in modo non uniforme.	<ul style="list-style-type: none"> - Aprire il coperchio. - Controllare il caricamento del rotore, vedere il capitolo "Carico del rotore". - Ripetere il ciclo di centrifugazione.
CONTROL - ERROR	4, 6	Errore blocco coperchio, ovvero chiusura coperchio.	<ul style="list-style-type: none"> - Esecuzione di un RESET RETE.
N > MAX	5	N° giri eccedente	
N < MIN	13	N° giri insufficiente	
MAINS INTERRUPT	---	Interruzione di rete durante il ciclo di centrifugazione. (Il ciclo di centrifugazione non viene terminato.)	<ul style="list-style-type: none"> - Aprire il coperchio. - Premere tasto START/IMPULS. - All'occorrenza ripetere il ciclo di centrifugazione.
ROTORCODE	10.1, 10.2	Errore codifica rotore	<ul style="list-style-type: none"> - Aprire il coperchio.
CONTROL-ERROR	21, 22, 25, 27, 29	Guasto/difetto sistema elettronico.	<ul style="list-style-type: none"> - Esecuzione di un RESET RETE.
CONTROL-ERROR	23	Guasto/difetto parte comando.	
SER I/O - ERROR	30, 31, 33, 36	Guasto/difetto sistema elettronico.	
° C * - ERROR	51 - 53, 55	Guasto/difetto sistema elettronico.	
FU / CCI - ERROR	60 - 64, 67, 68, 82 - 86	Guasto/difetto sistema elettronico/motore.	
SYNC-ERROR	90	Guasto/difetto sistema elettronico.	
SENSOR-ERROR	91 - 93	Guasto/difetto sensore squilibrio.	
KEYBOARD-ERROR	---	Guasto/difetto parte comando.	
NO ROTOR	---	Non è installato alcun rotore	<ul style="list-style-type: none"> - Aprire il coperchio. - Installare il rotore.
N > ROTOR MAX	---	Il numero di giri nel programma selezionato è superiore al numero di giri massimo del rotore.	<ul style="list-style-type: none"> - Verificare e correggere la velocità nel programma selezionato.
		Il rotore è stato cambiato. Il rotore installato ha un numero di giri superiore del precedente e non è stato ancora riconosciuto.	<ul style="list-style-type: none"> - Impostare un numero di giri massimo superiore a quello del rotore precedentemente utilizzato. Premere il tasto START/IMPULS per effettuare il riconoscimento del rotore, vedi capitolo "Riconoscimento del rotore".

27 Rispedizione di apparecchi



Prima di rispedire un apparecchio deve essere montata la protezione per il trasporto.

Se l'apparecchio o uno dei suoi accessori viene rispedito alla ditta Andreas Hettich GmbH & Co. KG, esso deve essere prima decontaminato e pulito per la tutela di persone, ambiente e materiale.

Ci riserviamo la facoltà di accettare apparecchi o accessori contaminati.

Eventuali costi di pulizia e disinfezione verranno fatturati al cliente.

Contiamo a questo riguardo sulla vostra comprensione.

28 Smaltimento

Prima dello smaltimento, l'apparecchiatura deve essere decontaminata e pulita con lo scopo di proteggere le persone, l'ambiente e il materiale.

Per lo smaltimento dell'apparecchio osservare le rispettive norme di legge.

Ai sensi della direttiva 2002/96/CE (RAEE) tutti gli apparecchi forniti dopo il 13/08/2005 non possono più essere smaltiti con i rifiuti domestici. Questo apparecchio appartiene alla categoria 8 (Dispositivi medicali) ed è classificato nel settore Business-to-Business.



Il simbolo della pattumiera cancellata con una croce indica che l'apparecchio non deve essere smaltito con i rifiuti domestici.

Le norme per lo smaltimento possono essere differenti nei singoli paesi UE. In caso di necessità rivolgersi al proprio rivenditore.

29 Anhang / Appendix

29.1 Rotoren und Zubehör / Rotors and accessories

	1429	1734	<p>Nicht in UNIVERSAL 320 / 320 R, BOECO U-320/320R, Cellspin II zugelassen. Not permitted in UNIVERSAL 320 / 320 R, BOECO U-320/320R, Cellspin II.</p>

<p>1324 Ausschwingrotor 4-fach / Swing out rotor 4-times</p> <p>90°</p>	<p>1390 + 1382</p> <p>mit Bioabdichtung / with bio-containment 5)</p>								
	0765		1329				1330	1331	
	0534 4)	0535	0500	0507			0519	0521	
Kapazität / capacity	ml	30	9	15	9 - 10	10	25	50	
Maße / dimensions Ø x L	mm	44 x 105	14 x 100	17 x 100	16 x 92	15 x 102	24 x 100	34 x 100	
Anzahl p. Rotor / number p. rotor		4	16	16	16	16	4	4	
Drehzahl / speed	RPM	4500	4500	4500	4500	4500	4500	4500	
RZB / RCF	³⁾	3170	3170	3170	3170	3328	3034	3011	
Radius / radius	mm	140	140	140	140	147	134	133	
	9 (97%)	27							
	9	30							
Temperatur / temperature	°C ¹⁾	- 6							
Probenerwärmung/Sample temp. rise	K ²⁾	+ 10							

- 1) Tiefste erreichbare Temperatur bei maximaler Drehzahl, 1 h Laufzeit und 20°C Raumtemperatur (nur bei Kühlzentrifuge)
- 2) Probenerwärmung bei maximaler Drehzahl und 1 Stunde Laufzeit (nur bei Zentrifuge ohne Kühlung)
- 3) Zentrifugiergefäße aus Glas nur belastbar bis RZB 4000
- 4) nicht mit Stopfen zentrifugierbar, Skal. 10µl-300µl, 15ml, 30ml
- 5) Nach DIN EN 61010, Teil 2 – 020. Die Hinweise für Bio-Sicherheitssysteme in den Kapiteln "Sicherheitshinweise" und "Pflege und Wartung" beachten
- 6) Die Einlagen entfernen



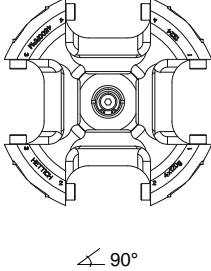
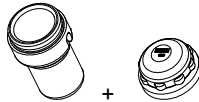

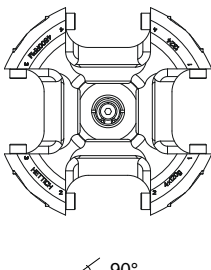
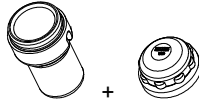





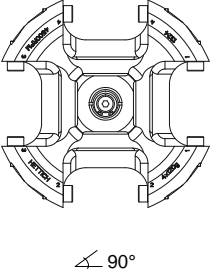
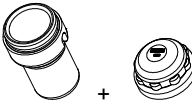

- 1) Lowest possible temperature during maximum speed, 1 h running time and 20°C ambient temperature (only with cooling centrifuges)
- 2) Sample temp. rise during maximum speed and 1 hour running time (only with centrifuges without cooling)
- 3) Centrifuge containers of glass will not stand RCF values exceeding 4000
- 4) can not be centrifugated when plug is attached, Scal. 10µl-300µl, 15ml, 30ml
- 5) in conformity with DIN EN 61010, part 2 – 020. Observe the notes for bio safety systems in chapters "Notes on safety" and "Maintenance and servicing".
- 6) Remove the inserts

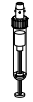









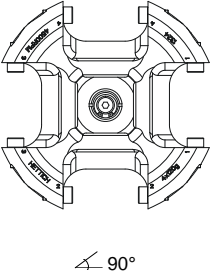
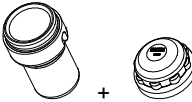



1324		1390 + 1382							
Ausschwingrotor 4-fach / Swing out rotor 4-times  90°		 mit Bioabdichtung / with bio-containment 5)							
		1339		1343		1347		1348	
		Rhesus			0509				
Kapazität / capacity	ml	1	3	4	15	10	8	4 – 4,5	4 - 7
Maße / dimensions	∅ x L mm	6 x 45	10 x 60	10 x 88	17 x 120	16 x 80	16 x 81	15 x 75	16 x 75
Anzahl p. Rotor / number p. rotor		108	36	36	4	16	16	16	16
Drehzahl / speed	RPM	4500	4500	4500	4500	4500	4500	4500	4500
RZB / RCF	³⁾	3237	3283	3283	3328	3147	3147	3147	3147
Radius / radius	mm	143	145	145	147	139	139	139	139
9 (97%)	sec	27							
9	sec	30							
Temperatur / temperature	°C ¹⁾	- 6							
Probenerwärmung/Sample temp. rise	K ²⁾	+ 10							

1324		1390 + 1382									
Ausschwingrotor 4-fach / Swing out rotor 4-times  90°		 mit Bioabdichtung / with bio-containment 5)									
		1348		1351		1363		1365		1383	
			2078	0536				0501			
Kapazität / capacity	ml	8,5 - 10	1,5	2,0	25	30	5	6	7	2,7 - 3	
Maße / dimensions	∅ x L mm	16 x 100	11 x 38	25 x 90	25 x 110	12 x 75	12 x 82	12 x 100	11 x 66		
Anzahl p. Rotor / number p. rotor		16	20	4	4	20	20	20	20		
Drehzahl / speed	RPM	4500	4500	4500	4500	4500	4500	4500	4500		
RZB / RCF	³⁾	3147	3056	2920	3328	3192	3192	3192	3192		
Radius / radius	mm	139	135	129	147	141	141	141	141		
9 (97%)	sec	27									
9	sec	30									
Temperatur / temperature	°C ¹⁾	- 6									
Probenerwärmung/Sample temp. rise	K ²⁾	+ 10									

- 1) Tiefste erreichbare Temperatur bei maximaler Drehzahl, 1 h Laufzeit und 20°C Raumtemperatur (nur bei Kühlzentrifuge)
- 2) Probenerwärmung bei maximaler Drehzahl und 1 Stunde Laufzeit (nur bei Zentrifuge ohne Kühlung)
- 3) Zentrifugiergefäße aus Glas nur belastbar bis RZB 4000
- 5) Nach DIN EN 61010, Teil 2 – 020. Die Hinweise für Bio-Sicherheitssysteme in den Kapiteln "Sicherheitshinweise" und "Pflege und Wartung" beachten











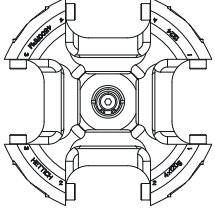

- 1) Lowest possible temperature during maximum speed, 1 h running time and 20°C ambient temperature (only with cooling centrifuges)
- 2) Sample temp. rise during maximum speed and 1 hour running time (only with centrifuges without cooling)
- 3) Centrifuge containers of glass will not stand RCF values exceeding 4000
- 5) in conformity with DIN EN 61010, part 2 – 020. Observe the notes for bio safety systems in chapters "Notes on safety" and "Maintenance and servicing".







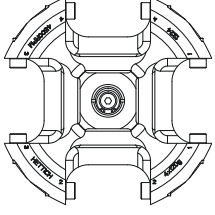

1324	1390 + 1382								
Ausschwingrotor 4-fach / Swing out rotor 4-times  ↙ 90°	 +								
	mit Bioabdichtung / with bio-containment 5)								
	1383			1384		1396		1457	
									
						0513 		0547 	
Kapazität / capacity	ml	2,6 – 2,9	4,9	4,5 - 5	1,6 -5	4 –7	50	85	1,1 – 1,4
Maße / dimensions	∅ x L	mm	13 x 65	13 x 90	11 x 92	13 x 75	13 x 100	29 x 115	38 x 66
Anzahl p. Rotor / number p. rotor		20	20	20	20	20	4	4	28
Drehzahl / speed	RPM	4500	4500	4500	4500	4500	4500	4500	4500
RZB / RCF	³⁾	3192	3192	3192	3129	3129	3328	3260	3215
Radius / radius	mm	141	141	141	141	141	147	144	142
 9 (97%)	sec	27							
 9	sec	30							
Temperatur / temperature	°C ¹⁾	- 6							
Probenerwärmung/Sample temp. rise	K ²⁾	+ 10							

1324	1390 + 1382									
Ausschwingrotor 4-fach / Swing out rotor 4-times  ↙ 90°	 +									
	mit Bioabdichtung / with bio-containment 5)									
	1459		4416		4417		6311		6318	
										
			0546 		0545 		--- 		0509 	
Kapazität / capacity	ml	4 – 5,5	7,5 – 8,2	50	30	12	50	15	100	
Maße / dimensions	∅ x L	mm	15 x 75	15 x 92	29 x 107	26 x 95	17 x 100	29 x 115	17 x 120	44 x 100
Anzahl p. Rotor / number p. rotor		16	16	4	4	4	4	12	4	
Drehzahl / speed	RPM	4500	4500	4500	4500	4500	4500	4500	4500	
RZB / RCF	³⁾	3215	3215	3283	3056	3328	3328	3328	3192	
Radius / radius	mm	142	142	145	135	147	147	147	141	
 9 (97%)	sec	27								
 9	sec	30								
Temperatur / temperature	°C ¹⁾	- 6								
Probenerwärmung/Sample temp. rise	K ²⁾	+ 10								

- 1) Tiefste erreichbare Temperatur bei maximaler Drehzahl, 1 h Laufzeit und 20°C Raumtemperatur (nur bei Kühlzentrifuge)
- 2) Probenerwärmung bei maximaler Drehzahl und 1 Stunde Laufzeit (nur bei Zentrifuge ohne Kühlung)
- 3) Zentrifugiergefäße aus Glas nur belastbar bis RZB 4000
- 5) Nach DIN EN 61010, Teil 2 – 020. Die Hinweise für Bio-Sicherheitssysteme in den Kapiteln "Sicherheitshinweise" und "Pflege und Wartung" beachten











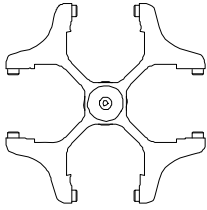

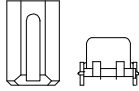



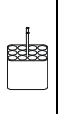









- 1) Lowest possible temperature during maximum speed, 1 h running time and 20°C ambient temperature (only with cooling centrifuges)
- 2) Sample temp. rise during maximum speed and 1 hour running time (only with centrifuges without cooling)
- 3) Centrifuge containers of glass will not stand RCF values exceeding 4000
- 5) in conformity with DIN EN 61010, part 2 – 020. Observe the notes for bio safety systems in chapters "Notes on safety" and "Maintenance and servicing".











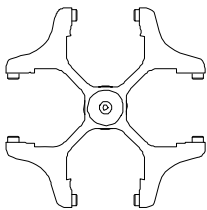

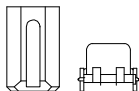







1324		1398								
Ausschwingrotor 4-fach / Swing out rotor 4-times  ↙ 90°										
		1482-A								
		+ 2 x 0716 								
								0500 	0507 	
Kapazität / capacity	ml	2,6 – 2,9	4 – 4,5	9 – 10	10	12	4 - 7	9	15	
Maße / dimensions	∅ x L	mm	13 x 65	15 x 75	16 x 92	15 x 102	17 x 100	16 x 75	14 x 100	17 x 100
Anzahl p. Rotor / number p. rotor		16	16	16	16	16	16	16	16	
Drehzahl / speed	RPM	4500	4500	4500	4500	4500	4500	4500	4500	
RZB / RCF	³⁾	2875	2875	3192	3192	3192	3034	3192	3192	
Radius / radius	mm	127	127	141	141	141	134	141	141	
 9 (97%)	sec							27		
 9	sec							30		
Temperatur / temperature	°C ¹⁾							- 6		
Probenerwärmung/Sample temp. rise	K ²⁾							+ 10		

1324		1398									
Ausschwingrotor 4-fach / Swing out rotor 4-times  ↙ 90°											
		1483-A		1484							
			ohne / without E2110								
	0509	Falcon®	0513								
											
Kapazität / capacity	ml	15	50	50							
Maße / dimensions	∅ x L	mm	17 x 120	29 x 115	29 x 115						
Anzahl p. Rotor / number p. rotor		16	4	4							
Drehzahl / speed	RPM	4500	4500	4500							
RZB / RCF	³⁾	3305	3260	3260							
Radius / radius	mm	146	144	144							
 9 (97%)	sec							27			
 9	sec							30			
Temperatur / temperature	°C ¹⁾							- 6			
Probenerwärmung/Sample temp. rise	K ²⁾							+ 10			

- 1) Tiefste erreichbare Temperatur bei maximaler Drehzahl, 1 h Laufzeit und 20°C Raumtemperatur (nur bei Kühlzentrifuge)
- 2) Probenerwärmung bei maximaler Drehzahl und 1 Stunde Laufzeit (nur bei Zentrifuge ohne Kühlung)
- 3) Zentrifugiergefäße aus Glas nur belastbar bis RZB 4000











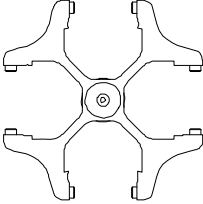

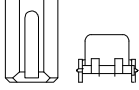



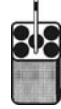

- 1) Lowest possible temperature during maximum speed, 1 h running time and 20°C ambient temperature (only with cooling centrifuges)
- 2) Sample temp. rise during maximum speed and 1 hour running time (only with centrifuges without cooling)
- 3) Centrifuge containers of glass will not stand RCF values exceeding 4000











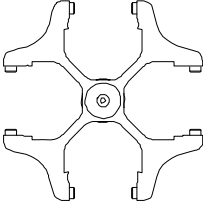

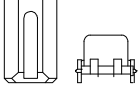



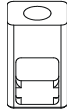
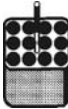



1494	1427 1421															
Ausschwingrotor 4-fach / Swing out rotor 4-times  																
	1357		5229 ⁴⁾		5229		1326		5230		5230 ⁴⁾		5231		5231 ⁴⁾	
																
Rhe- sus	---						0501		0578		0507					
																
Kapazität / capacity	ml	1	0,4	4,5 – 5	2,7 - 3	6	4	7	4,5 – 5	15	8,5 - 10					
Maße / dimensions	Ø x L	mm	6 x 45	11 x 92	11x 66	12 x 82	12 x 60	12 x 100	11 x 92	17 x 100	16 x 100					
Anzahl p. Rotor / number p. rotor		120	48	48	48	48	48	48	48	24	24					
Drehzahl / speed	RPM	5000	5000	5000	5000	5000	5000	5000	5000	5000	5000					
RZB / RCF	³⁾	4081	4053	4053	4053	4053	4053	3941	3941	3941	3941					
Radius / radius	mm	146	145	145	145	145	145	141	141	141	141					
 9 (97%)	sec	30														
 9	sec	32														
Temperatur / temperature	°C ¹⁾	- 7														
Probenerwärmung/Sample temp. rise	K ²⁾	+ 15														

1494	1427 1421											
Ausschwingrotor 4-fach / Swing out rotor 4-times  												
	1731 ⁴⁾		1732				1732 ⁴⁾		5237		5279	
												
												
Kapazität / capacity	ml	25	5	1,6 – 5	2,6 – 2,9	4,9	4 – 7	9	4 – 5,5			
Maße / dimensions	Ø x L	mm	25 x 90	12/13x75	13 x 75	13 x 65	13 x 90	13 x 100	14 x 100	15 x 75		
Anzahl p. Rotor / number p. rotor		8	32	32	32	32	32	24	20			
Drehzahl / speed	RPM	5000	5000	5000	5000	5000	5000	5000	5000			
RZB / RCF	³⁾	3969	4025	4025	4025	4025	4025	3941	4109			
Radius / radius	mm	142	144	144	144	144	144	141	147			
 9 (97%)	sec	30										
 9	sec	32										
Temperatur / temperature	°C ¹⁾	- 7										
Probenerwärmung/Sample temp. rise	K ²⁾	+ 15										

- 1) Tiefste erreichbare Temperatur bei maximaler Drehzahl, 1 h Laufzeit und 20°C Raumtemperatur (nur bei Kühlzentrifuge)
- 2) Probenerwärmung bei maximaler Drehzahl und 1 Stunde Laufzeit (nur bei Zentrifuge ohne Kühlung)
- 3) Zentrifugiergefäße aus Glas nur belastbar bis RZB 4000
- 4) nicht mit Deckel verschließbar











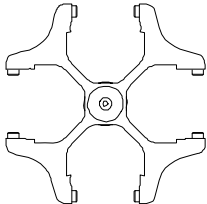





- 1) Lowest possible temperature during maximum speed, 1 h running time and 20°C ambient temperature (only with cooling centrifuges)
- 2) Sample temp. rise during maximum speed and 1 hour running time (only with centrifuges without cooling)
- 3) Centrifuge containers of glass will not stand RCF values exceeding 4000
- 4) not possible to close the lid











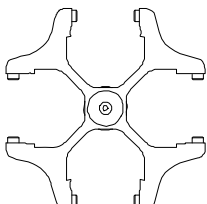

1494		1427 1421							
Ausschwingrotor 4-fach / Swing out rotor 4-times  									
		5279	5278	1327	5233	5271	5232	5275 ⁴⁾	
									
					0521 			0509 	
Kapazität / capacity	ml	7,5 – 8,2	1,1 – 1,4	3	50	9 - 10	4 - 7	25	15
Maße / dimensions	∅ x L	15 x 92	8 x 66	10 x 60	34 x 100	16 x 92	16 x 75	24 x 100	17 x 120
Anzahl p. Rotor / number p. rotor		20	48	48	4	20	20	8	4
Drehzahl / speed	RPM	5000	5000	5000	5000	5000	5000	5000	5000
RZB / RCF	³⁾	4109	4109	4053	3941	3969	3969	3941	4165
Radius / radius	mm	147	147	145	141	142	142	141	149
 9 (97%)	sec				30				
 9	sec				32				
Temperatur / temperature	°C ¹⁾				- 7				
Probenerwärmung/Sample temp. rise	K ²⁾				+ 15				

1494		1427 1421						1425				
Ausschwingrotor 4-fach / Swing out rotor 4-times  												
		5276 ⁴⁾	5277	5272	5273	1432	1433	1434				
												
		0513 	2078 	0536 	--- 	--- 	Rhe- sus 	--- 	0501 		0578 	
Kapazität / capacity	ml	50	1,5	2,0	30	1,5	2,0	1	0,4	3	6	7
Maße / dimensions	∅ x L	29 x 115	11 x 38	25 x 110	11 x 38	6 x 45	10 x 60	12 x 82	12 x 100	12 x 82	12 x 100	12 x 100
Anzahl p. Rotor / number p. rotor		4	36	4	48	144	56	48	48	48	48	48
Drehzahl / speed	RPM	5000	5000	5000	5000	5000	5000	5000	5000	5000	5000	5000
RZB / RCF	³⁾	4053	4109	4025	4053	3969	3913	3913	3913	3913	3913	3913
Radius / radius	mm	145	147	144	145	142	140	140	140	140	140	140
 9 (97%)	sec				30							
 9	sec				32							
Temperatur / temperature	°C ¹⁾				- 7							
Probenerwärmung/Sample temp. rise	K ²⁾				+ 15							

- 1) Tiefste erreichbare Temperatur bei maximaler Drehzahl, 1 h Laufzeit und 20°C Raumtemperatur (nur bei Kühlzentrifuge)
- 2) Probenerwärmung bei maximaler Drehzahl und 1 Stunde Laufzeit (nur bei Zentrifuge ohne Kühlung)
- 3) Zentrifugiergefäße aus Glas nur belastbar bis RZB 4000
- 4) nicht mit Deckel verschließbar
- 6) Die Einlagen entfernen









- 1) Lowest possible temperature during maximum speed, 1 h running time and 20°C ambient temperature (only with cooling centrifuges)
- 2) Sample temp. rise during maximum speed and 1 hour running time (only with centrifuges without cooling)
- 3) Centrifuge containers of glass will not stand RCF values exceeding 4000
- 4) not possible to close the lid
- 6) Remove the inserts

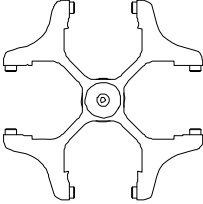

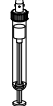
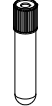
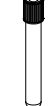

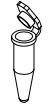
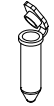





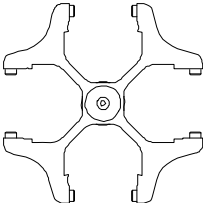





1494		1425															
Ausschwingrotor 4-fach / Swing out rotor 4-times  ∠ 90°																	
		1431		1436		1437		1458		1435		1439					
																	
0500		0507		0521		0526		0519		0519							
																	
Kapazität / capacity	ml	9		15		7,5 - 8,2		50		100		1,1 – 1,4		25		9 – 10	
Maße / dimensions	∅ x L	mm 14 x 100		mm 17 x 100		mm 15 x 92		mm 34 x 100		mm 44 x 100		mm 8 x 66		mm 24 x 100		mm 16 x 92	
Anzahl p. Rotor / number p. rotor		28		28		28		4		4		36		8		16	
Drehzahl / speed	RPM	5000		5000		5000		5000		5000		5000		5000		5000	
RZB / RCF	³⁾	3913		3913		3913		3913		3801		4025		3913		3913	
Radius / radius	mm	140		140		140		140		136		144		140		140	
 9 (97%)	sec											30					
 9	sec											32					
Temperatur / temperature	°C ¹⁾											- 10					
Probenerwärmung/Sample temp. rise	K ²⁾											+ 12					

1494		1425															
Ausschwingrotor 4-fach / Swing out rotor 4-times  ∠ 90°																	
		1438															
																	
																	
Kapazität / capacity	ml	2,6 – 2,9		2,7 – 3		4,9		4,5 – 5		1,6 – 5		4 – 7		5		4	
Maße / dimensions	∅ x L	mm 13 x 65		mm 11 x 66		mm 13 x 90		mm 11 x 92		mm 13 x 75		mm 13 x 100		mm 12/13x75		mm 12 x 60	
Anzahl p. Rotor / number p. rotor		28		28		28		28		28		28		28		28	
Drehzahl / speed	RPM	5000		5000		5000		5000		5000		5000		5000		5000	
RZB / RCF	³⁾	3913		3913		3913		3913		3913		3913		3913		3913	
Radius / radius	mm	140		140		140		140		140		140		140		140	
 9 (97%)	sec											30					
 9	sec											32					
Temperatur / temperature	°C ¹⁾											- 10					
Probenerwärmung/Sample temp. rise	K ²⁾											+ 12					

1) Tiefste erreichbare Temperatur bei maximaler Drehzahl, 1 h Laufzeit und 20°C Raumtemperatur (nur bei Kühlzentrifuge)
 2) Probenerwärmung bei maximaler Drehzahl und 1 Stunde Laufzeit (nur bei Zentrifuge ohne Kühlung)
 3) Zentrifugiergefäße aus Glas nur belastbar bis RZB 4000



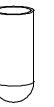







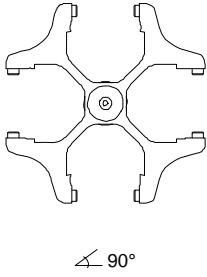
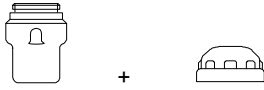

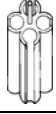



1) Lowest possible temperature during maximum speed, 1 h running time and 20°C ambient temperature (only with cooling centrifuges)
 2) Sample temp. rise during maximum speed and 1 hour running time (only with centrifuges without cooling)
 3) Centrifuge containers of glass will not stand RCF values exceeding 4000











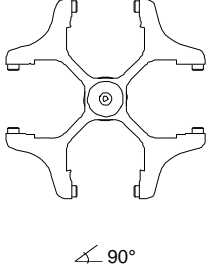





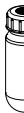

1494		1425								
Ausschwingrotor 4-fach / Swing out rotor 4-times  ∠ 90°										
		1441		1443		1444		1737		
		   				 				
Kapazität / capacity	ml	4 – 5,5	7,5 – 8,5	4 – 7	8,5 – 10	50	1,5	2,0	50	
Maße / dimensions	∅ x L	mm	15 x 75	15 x 92	16 x 75	16 x 100	29 x 115	11 x 38	11 x 38	29 x 115
Anzahl p. Rotor / number p. rotor			28	28	28	4	4	36	36	4
Drehzahl / speed	RPM	5000	5000	5000	5000	5000	5000	5000	5000	5000
RZB / RCF	³⁾	3913	3913	3913	3913	4081	3885	3885	3885	4081
Radius / radius	mm	140	140	140	140	146	139	139	139	146
 9 (97%)	sec	30								
 9	sec	32								
Temperatur / temperature	°C ¹⁾	- 10								
Probenerwärmung/Sample temp. rise	K ²⁾	+ 12								

1494		1430				1382				
Ausschwingrotor 4-fach / Swing out rotor 4-times  ∠ 90°		 + 								
		mit Bioabdichtung / with bio-containment ⁵⁾								
		1363		1365		1348		0761		
										
  						 				
Kapazität / capacity	ml	25	30	10	8	4 – 5,5	4 - 7	8,5 - 10	100	
Maße / dimensions	∅ x L	mm	25 x 90	25 x 110	16 x 80	16 x 81	15 x 75	16 x 75	16 x 100	44 x 100
Anzahl p. Rotor / number p. rotor			4	4	16	16	16	16	16	4
Drehzahl / speed	RPM	5000	5000	5000	5000	5000	5000	5000	5000	5000
RZB / RCF	³⁾	3689	4193	4025	4025	4025	4025	4025	4025	4025
Radius / radius	mm	132	150	144	144	144	144	144	144	144
 9 (97%)	sec	30								
 9	sec	32								
Temperatur / temperature	°C ¹⁾	- 10								
Probenerwärmung/Sample temp. rise	K ²⁾	+ 14								

- 1) Tiefste erreichbare Temperatur bei maximaler Drehzahl, 1 h Laufzeit und 20°C Raumtemperatur (nur bei Kühlzentrifuge)
- 2) Probenerwärmung bei maximaler Drehzahl und 1 Stunde Laufzeit (nur bei Zentrifuge ohne Kühlung)
- 3) Zentrifugiergefäße aus Glas nur belastbar bis RZB 4000
- 5) Nach DIN EN 61010, Teil 2 – 020. Die Hinweise für Bio-Sicherheitssysteme in den Kapiteln "Sicherheitshinweise" und "Pflege und Wartung" beachten



- 1) Lowest possible temperature during maximum speed, 1 h running time and 20°C ambient temperature (only with cooling centrifuges)
- 2) Sample temp. rise during maximum speed and 1 hour running time (only with centrifuges without cooling)
- 3) Centrifuge containers of glass will not stand RCF values exceeding 4000
- 5) in conformity with DIN EN 61010, part 2 – 020. Observe the notes for bio safety systems in chapters "Notes on safety" and "Maintenance and servicing".



1494	1430				1382					
Ausschwingrotor 4-fach / Swing out rotor 4-times  90°	 +									
	mit Bioabdichtung / with bio-containment 5)									
	1339	1343	1329		1330	1459				
										
Rhe- sus	---			0500	0507		0519			
										
Kapazität / capacity ml	1	0,4	3	4	9	15	9 - 10	25	4 - 5,5	7,5 - 8,2
Maße / dimensions Ø x L mm	6 x 45		10 x 60	10 x 88	14 x 100	17 x 100	16 x 92	24 x 100	15 x 75	15 x 92
Anzahl p. Rotor / number p. rotor	108		36		16	16	16	4	16	16
Drehzahl / speed RPM	5000		5000		5000	5000	5000	5000	5000	5000
RZB / RCF 3)	4081		4137		3997	3997	3997	3829	4053	4053
Radius / radius mm	146		148		143	143	143	137	145	145
 9 (97%)									30	
 9									32	
Temperatur / temperature °C 1)									- 10	
Probenerwärmung/Sample temp. rise K 2)									+ 14	

1494	1430				1382					
Ausschwingrotor 4-fach / Swing out rotor 4-times  90°	 +									
	mit Bioabdichtung / with bio-containment 5)									
	1331	1396	4416	4417	0761	1457	1383			
										
0521	0547	0546	0545	0526						
										
Kapazität / capacity ml	50	85	50	30	100	1,1 – 1,4	1,6 – 5	4 – 7		
Maße / dimensions Ø x L mm	34 x 100		38 x 106	29 x 107	26 x 95	44 x 100	8 x 66	13 x 75	13 x 100	
Anzahl p. Rotor / number p. rotor	4		4	4	4	4	28	20	20	
Drehzahl / speed RPM	5000		5000	5000	5000	5000	5000	5000	5000	
RZB / RCF 3)	3801		4109	4137	3857	4025	4053	4025	4025	
Radius / radius mm	136		147	148	138	144	145	144	144	
 9 (97%)									30	
 9									32	
Temperatur / temperature °C 1)									- 10	
Probenerwärmung/Sample temp. rise K 2)									+ 14	

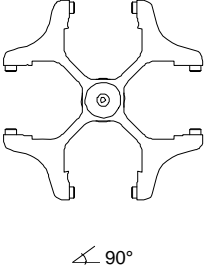
- 1) Tiefste erreichbare Temperatur bei maximaler Drehzahl, 1 h Laufzeit und 20°C Raumtemperatur (nur bei Kühlzentrifuge)
- 2) Probenerwärmung bei maximaler Drehzahl und 1 Stunde Laufzeit (nur bei Zentrifuge ohne Kühlung)
- 3) Zentrifugiergefäße aus Glas nur belastbar bis RZB 4000
- 5) Nach DIN EN 61010, Teil 2 – 020. Die Hinweise für Bio-Sicherheitssysteme in den Kapiteln "Sicherheitshinweise" und "Pflege und Wartung" beachten



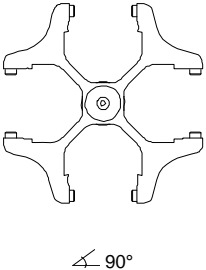



- 1) Lowest possible temperature during maximum speed, 1 h running time and 20°C ambient temperature (only with cooling centrifuges)
- 2) Sample temp. rise during maximum speed and 1 hour running time (only with centrifuges without cooling)
- 3) Centrifuge containers of glass will not stand RCF values exceeding 4000
- 5) in conformity with DIN EN 61010, part 2 – 020. Observe the notes for bio safety systems in chapters "Notes on safety" and "Maintenance and servicing".



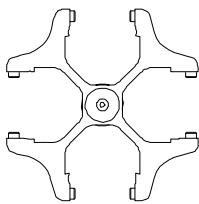



1494	1430				1382				
Ausschwingrotor 4-fach / Swing out rotor 4-times  ∠ 90°	 mit Bioabdichtung / with bio-containment 5)								
	1383								
					0501	0578	---		
Kapazität / capacity	ml	2,6 – 2,9	2,7 – 3	4,9	4,5 - 5	6	7	5	
Maße / dimensions	∅ x L	mm	13 x 65	11 x 66	13 x 90	11 x 92	12 x 82	12 x 100	12/13x75
Anzahl p. Rotor / number p. rotor		20	20	20	20	20	20	20	
Drehzahl / speed	RPM	5000	5000	5000	5000	5000	5000	5000	
RZB / RCF	³⁾	4025	4025	4025	4025	4025	4025	4025	
Radius / radius	mm	144	144	144	144	144	144	144	
9 (97%)	sec	30							
9	sec	32							
Temperatur / temperature	°C ¹⁾	- 10							
Probenerwärmung/Sample temp. rise	K ²⁾	+ 14							

1494	1430				1382				
Ausschwingrotor 4-fach / Swing out rotor 4-times  ∠ 90°	 mit Bioabdichtung / with bio-containment 5)								
	1351	1347	1384	0765		6311	6318		
	2078	0536	0509	0513	0534 4)	0535	Falcon®		
Kapazität / capacity	ml	1,5	2,0	15	50	30	12	50	
Maße / dimensions	∅ x L	mm	11 x 38	11 x 38	17 x 120	29 x 115	44 x 105	17 x 100	29 x 115
Anzahl p. Rotor / number p. rotor		20	20	4	4	4	4	4	
Drehzahl / speed	RPM	5000	5000	5000	5000	5000	5000	5000	
RZB / RCF	³⁾	3857	3857	4193	4193	3997	4193	4193	
Radius / radius	mm	138	138	150	150	143	150	150	
9 (97%)	sec	30							
9	sec	32							
Temperatur / temperature	°C ¹⁾	- 10							
Probenerwärmung/Sample temp. rise	K ²⁾	+ 14							

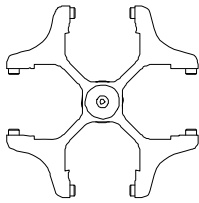
- 1) Tiefste erreichbare Temperatur bei maximaler Drehzahl, 1 h Laufzeit und 20°C Raumtemperatur (nur bei Kühlzentrifuge)
- 2) Probenerwärmung bei maximaler Drehzahl und 1 Stunde Laufzeit (nur bei Zentrifuge ohne Kühlung)
- 3) Zentrifugiergefäße aus Glas nur belastbar bis RZB 4000
- 4) nicht mit Stopfen zentrifugierbar, Skal. 10µl-300µl, 15ml, 30ml
- 5) Nach DIN EN 61010, Teil 2 – 020. Die Hinweise für Bio-Sicherheitssysteme in den Kapiteln "Sicherheitshinweise" und "Pflege und Wartung" beachten



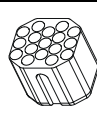





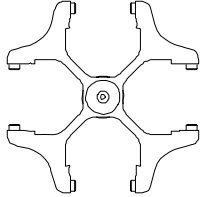
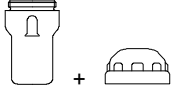

- 1) Lowest possible temperature during maximum speed, 1 h running time and 20°C ambient temperature (only with cooling centrifuges)
- 2) Sample temp. rise during maximum speed and 1 hour running time (only with centrifuges without cooling)
- 3) Centrifuge containers of glass will not stand RCF values exceeding 4000
- 4) can not be centrifugated when plug is attached, Scal. 10µl-300µl, 15ml, 30ml
- 5) in conformity with DIN EN 61010, part 2 – 020. Observe the notes for bio safety systems in chapters "Notes on safety" and "Maintenance and servicing".









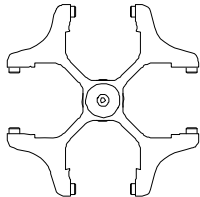
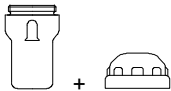

1624		1308	1345	1346	1366					
Ausschwingrotor 4-fach / Swing out rotor 4-times  ∠ 90°										
					1326	1357	5277			
		0521					Rhe- sus		2078	0536
Kapazität / capacity	ml	50	45	20	4	0,4	1	3	1,5	2,0
Maße / dimensions	∅ x L	mm	34 x 100	31 x 100	21 x 100	12 x 60	6 x 45	10 x 60	11 x 38	
Anzahl p. Rotor / number p. rotor		4	4	8	48	120	36	36		
Drehzahl / speed	RPM	4000	4000	4000	4000	4000	4000	4000	4000	4000
RZB / RCF		2290	2361	2361	1932	1950	1968	1968	1968	1968
Radius / radius	mm	128	132	132	108	109	110	110	110	110
 9 (97%)	sec	20								
 9	sec	25								
Temperatur / temperature	°C ¹⁾	- 15								
Probenerwärmung/Sample temp. rise	K ²⁾	+ 8								

1624											
Ausschwingrotor 4-fach / Swing out rotor 4-times  ∠ 90°											
		1369		1369-91		1369-92		1370		1372	
											
0507			0578	0501	0500						
Kapazität / capacity	ml	15	8,5 - 10	5	7	6	9	5			
Maße / dimensions	∅ x L	mm	17 x 100	16 x 100	12 x 75	12 x 100	12 x 82	14 x 100	12 x 75		
Anzahl p. Rotor / number p. rotor		16	16	16	16	16	20	68			
Drehzahl / speed	RPM	4000	4000	4000	4000	4000	4000	4000	4000		
RZB / RCF		2308	2308	2057	2308	2308	2308	2308	2164		
Radius / radius	mm	129	129	115	129	129	129	129	121		
 9 (97%)	sec	20									
 9	sec	25									
Temperatur / temperature	°C ¹⁾	- 17									
Probenerwärmung/Sample temp. rise	K ²⁾	+ 8									

1) Tiefste erreichbare Temperatur bei maximaler Drehzahl, 1 h Laufzeit und 20°C Raumtemperatur (nur bei Kühlzentrifuge)
 2) Probenerwärmung bei maximaler Drehzahl und 1 Stunde Laufzeit (nur bei Zentrifuge ohne Kühlung)
 3) Zentrifugiergefäße aus Glas nur belastbar bis RZB 4000

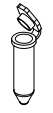

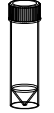







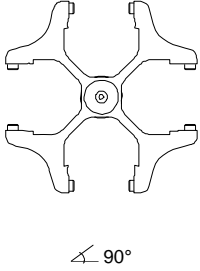
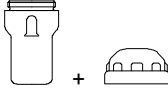

1) Lowest possible temperature during maximum speed, 1 h running time and 20°C ambient temperature (only with cooling centrifuges)
 2) Sample temp. rise during maximum speed and 1 hour running time (only with centrifuges without cooling)
 3) Centrifuge containers of glass will not stand RCF values exceeding 4000











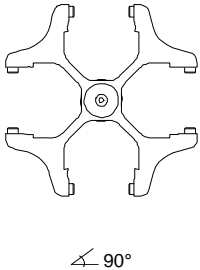
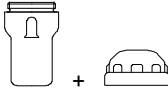







1624	1381 1382								
Ausschwingrotor 4-fach / Swing out rotor 4-times  ∠ 90°	 mit Bioabdichtung / with bio-containment 5)								
	1329				1330	1331	1339	1347	
	0500	0507			0519	0521	Rhesus	0509	
									
Kapazität / capacity ml	9	15	9 - 10	10	25	50	1	15	
Maße / dimensions Ø x L mm	14 x 100	17 x 100	16 x 92	15 x 102	24 x 100	34 x 100	6 x 45	17 x 120	
Anzahl p. Rotor / number p. rotor	16	16	16	16	4	4	108	4	
Drehzahl / speed RPM	4000	4000	4000	4000	4000	4000	4000	4000	
RZB / RCF	2540	2540	2540	2540	2433	2415	2594	2665	
Radius / radius mm	142	142	142	142	136	135	145	149	
 9 (97%) sec	20								
 9 sec	25								
Temperatur / temperature °C ¹⁾	- 15								
Probenerwärmung/Sample temp. rise K ²⁾	+ 7								

1624	1381 1382								
Ausschwingrotor 4-fach / Swing out rotor 4-times  ∠ 90°	 mit Bioabdichtung / with bio-containment 5)								
	1348				1351		6311	6318	
					2078	0536		Falcon®	
									
Kapazität / capacity ml	10	4 - 7	8,5 - 10	8	1,5	2,0	12	50	
Maße / dimensions Ø x L mm	16 x 80	16 x 75	16 x 100	16 x 81	11 x 38	11 x 38	17 x 100	29 x 115	
Anzahl p. Rotor / number p. rotor	16	16	16	16	20	20	4	4	
Drehzahl / speed RPM	4000	4000	4000	4000	4000	4000	4000	4000	
RZB / RCF	2522	2522	2522	2522	2451	2451	2665	2665	
Radius / radius mm	141	141	141	141	137	137	149	149	
 9 (97%) sec	20								
 9 sec	25								
Temperatur / temperature °C ¹⁾	- 15								
Probenerwärmung/Sample temp. rise K ²⁾	+ 7								

- 1) Tiefste erreichbare Temperatur bei maximaler Drehzahl, 1 h Laufzeit und 20°C Raumtemperatur (nur bei Kühlzentrifuge)
- 2) Probenerwärmung bei maximaler Drehzahl und 1 Stunde Laufzeit (nur bei Zentrifuge ohne Kühlung)
- 5) Nach DIN EN 61010, Teil 2 – 020. Die Hinweise für Bio-Sicherheitssysteme in den Kapiteln "Sicherheitshinweise" und "Pflege und Wartung" beachten
- 6) Die Einlagen entfernen











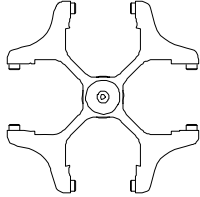
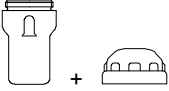







- 1) Lowest possible temperature during maximum speed, 1 h running time and 20°C ambient temperature (only with cooling centrifuges)
- 2) Sample temp. rise during maximum speed and 1 hour running time (only with centrifuges without cooling)
- 5) in conformity with DIN EN 61010, part 2 – 020. Observe the notes for bio safety systems in chapters "Notes on safety" and "Maintenance and servicing".
- 6) Remove the inserts

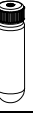









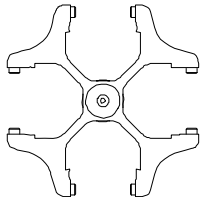
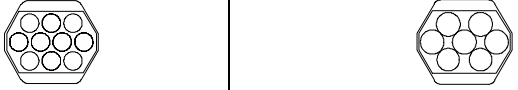



1624	1381 1382								
Ausschwingrotor 4-fach / Swing out rotor 4-times  90°	 +								
	mit Bioabdichtung / with bio-containment 5)								
	1383 								
	0501	0578							---
									
Kapazität / capacity	ml	6	7	4,9	4,5 - 5,0	2,7 - 3,0	2,6 - 2,9	1,6 - 5,0	5
Maße / dimensions	Ø x L	mm	12 x 82	12 x 100	13 x 90	11 x 92	11 x 66	13 x 75	12 x 75
Anzahl p. Rotor / number p. rotor		20	20	20	20	20	20	20	20
Drehzahl / speed	RPM	4000	4000	4000	4000	4000	4000	4000	4000
RZB / RCF		2558	2558	2558	2558	2558	2558	2558	2558
Radius / radius	mm	143	143	143	143	143	143	143	143
 9 (97%)	sec	20							
 9	sec	25							
Temperatur / temperature	°C ¹⁾	- 15							
Probenerwärmung/Sample temp. rise	K ²⁾	+ 7							

1624	1381 1382									
Ausschwingrotor 4-fach / Swing out rotor 4-times  90°	 +									
	mit Bioabdichtung / with bio-containment 5)									
	1383	1384	1396	1457	1343	1363	1365			
										
	0513	0547								
										
Kapazität / capacity	ml	4 - 7,0	50	85	1,1 - 1,4	3	4	25	30	
Maße / dimensions	Ø x L	mm	13 x 100	29 x 115	38 x 106	8 x 66	10 x 60	10 x 88	25 x 90	25 x 110
Anzahl p. Rotor / number p. rotor		20	4	4	28	36	36	4	4	
Drehzahl / speed	RPM	4000	4000	4000	4000	4000	4000	4000	4000	
RZB / RCF		2558	2665	2612	2576	2630	2630	2343	2665	
Radius / radius	mm	143	149	146	144	147	147	131	149	
 9 (97%)	sec	20								
 9	sec	25								
Temperatur / temperature	°C ¹⁾	- 15								
Probenerwärmung/Sample temp. rise	K ²⁾	+ 7								

- 1) Tiefste erreichbare Temperatur bei maximaler Drehzahl, 1 h Laufzeit und 20°C Raumtemperatur (nur bei Kühlzentrifuge)
- 2) Probenerwärmung bei maximaler Drehzahl und 1 Stunde Laufzeit (nur bei Zentrifuge ohne Kühlung)
- 5) Nach DIN EN 61010, Teil 2 - 020. Die Hinweise für Bio-Sicherheitssysteme in den Kapiteln "Sicherheitshinweise" und "Pflege und Wartung" beachten











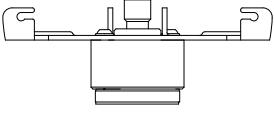



- 1) Lowest possible temperature during maximum speed, 1 h running time and 20°C ambient temperature (only with cooling centrifuges)
- 2) Sample temp. rise during maximum speed and 1 hour running time (only with centrifuges without cooling)
- 5) in conformity with DIN EN 61010, part 2 - 020. Observe the notes for bio safety systems in chapters "Notes on safety" and "Maintenance and servicing".











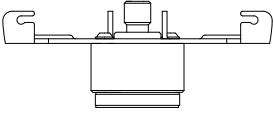

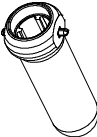
1624		1381 1382										
Ausschwingrotor 4-fach / Swing out rotor 4-times  ∠ 90°		 mit Bioabdichtung / with bio-containment 5)										
		1459	4416	4417	0761	0765		1745		1746		
												
		0546	0545	0526	0534 4)	0535	0519	0545	0521			
												
Kapazität / capacity	ml	4,0 - 5,5	7,5 - 8,2	50	30	100	30		25	30	50	
Maße / dimensions	∅ x L	15 x 75	15 x 92	29 x 107	26 x 95	44 x 10	44 x 105		24 x 100	26 x 95	34 x 100	
Anzahl p. Rotor / number p. rotor		16		4	4	4	4		8		4	
Drehzahl / speed	RPM	4000		4000	4000	4000	4000		4000		4000	
RZB / RCF		2576		2630	2451	2558	2540		2451		2451	
Radius / radius	mm	144		147	137	143	142		137		137	
 9 (97%)	sec					20						
 9	sec					25						
Temperatur / temperature	°C 1)					- 15						
Probenerwärmung/Sample temp. rise	K 2)					+ 7						

1624		1741				1742						
Ausschwingrotor 4-fach / Swing out rotor 4-times  ∠ 90°		 mit Bioabdichtung / with bio-containment 5)										
		0701				0716						
												
		0500			0507	0518						
												
Kapazität / capacity	ml	9	1,1 – 1,4		4,9	15	15	1,6 – 5	4 - 7	2,6 – 2,9	4 – 5,5	
Maße / dimensions	∅ x L	14 x 100	8 x 66		13 x 90	17 x 100	17 x 100	13 x 75	16 x 75	13 x 65	15 x 75	
Anzahl p. Rotor / number p. rotor		40	40		40	28	28	28		28		
Drehzahl / speed	RPM	4000	4000		4000	4000	4000	4000		4000		
RZB / RCF		2415	2415		2451	2451	2451	2325		2325		
Radius / radius	mm	135	135		137	137	137	130		130		
 9 (97%)	sec					20						
 9	sec					25						
Temperatur / temperature	°C 1)					- 15						
Probenerwärmung/Sample temp. rise	K 2)					+ 9						

- 1) Tiefste erreichbare Temperatur bei maximaler Drehzahl, 1 h Laufzeit und 20°C Raumtemperatur (nur bei Kühlzentrifuge)
- 2) Probenerwärmung bei maximaler Drehzahl und 1 Stunde Laufzeit (nur bei Zentrifuge ohne Kühlung)
- 4) nicht mit Stopfen zentrifugierbar, Skal. 10µl-300µl, 15ml, 30ml
- 5) Nach DIN EN 61010, Teil 2 – 020. Die Hinweise für Bio-Sicherheitssysteme in den Kapiteln "Sicherheitshinweise" und "Pflege und Wartung" beachten











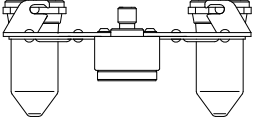

- 1) Lowest possible temperature during maximum speed, 1 h running time and 20°C ambient temperature (only with cooling centrifuges)
- 2) Sample temp. rise during maximum speed and 1 hour running time (only with centrifuges without cooling)
- 4) can not be centrifugated when plug is attached, Scal. 10µl-300µl, 15ml, 30ml
- 5) in conformity with DIN EN 61010, part 2 – 020. Observe the notes for bio safety systems in chapters "Notes on safety" and "Maintenance and servicing".





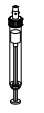

1611	1131					1132		
Ausschwingrotor 8-fach / Swing out rotor 8-times  								
	---	0501				2079		
								
Kapazität / capacity ml	5	6	2,7 – 3,0	2,6 - 2,9	1,6 – 5,0	10	4 – 5,5	4 - 7
Maße / dimensions Ø x L mm	12/13 x 75	12 x 82	11 x 66	13 x 65	13 x 75	17 x 70	15 x 75	16 x 75
Anzahl p. Rotor / number p. rotor	8	8	8	8	8	8	8	8
Drehzahl / speed RPM	4000	4000	4000	4000	4000	4000	4000	4000
RZB / RCF	1914	1914	1914	1914	1914	1914	1914	1914
Radius / radius mm	107	107	107	107	107	107	107	107
 9 (97%) sec						20		
 9 sec						20		
Temperatur / temperature °C ¹⁾						- 16		
Probenerwärmung/Sample temp. rise K ²⁾						+ 4		

1611	1643				1644			
Ausschwingrotor 8-fach / Swing out rotor 8-times  								
	0578				0507			
								
Kapazität / capacity ml	7	4 – 7	10	4,5 - 5	15	7,5 – 8,2	8,5 - 10	
Maße / dimensions Ø x L mm	12 x 100	13 x 100	13 x 100	11 x 92	17 x 100	15 x 92	16 x 100	
Anzahl p. Rotor / number p. rotor	8	8	8	8	8	8	8	
Drehzahl / speed RPM	4000	4000	4000	4000	4000	4000	4000	
RZB / RCF	2415	2415	2415	2415	2415	2415	2415	
Radius / radius mm	135	135	135	135	135	135	135	
 9 (97%) sec						20		
 9 sec						20		
Temperatur / temperature °C ¹⁾						- 16		
Probenerwärmung/Sample temp. rise K ²⁾						+ 7		

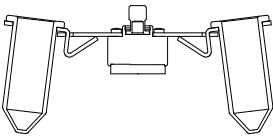
1) Tiefste erreichbare Temperatur bei maximaler Drehzahl, 1 h Laufzeit und 20°C Raumtemperatur (nur bei Kühlzentrifuge)
 2) Probenerwärmung bei maximaler Drehzahl und 1 Stunde Laufzeit (nur bei Zentrifuge ohne Kühlung)

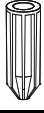





1) Lowest possible temperature during maximum speed, 1 h running time and 20°C ambient temperature (only with cooling centrifuges)
 2) Sample temp. rise during maximum speed and 1 hour running time (only with centrifuges without cooling)



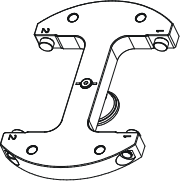

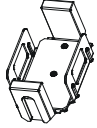
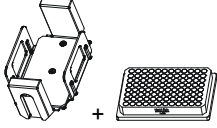
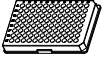
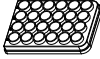
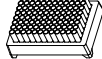

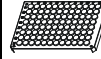
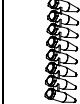



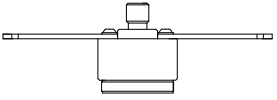





1619									
Ausschwingrotor 6-fach / Swing out rotor 6-times  		1462-A							
			---	SK 56.04-4					
		0509	0513						
									
Kapazität / capacity	ml	15	50	12	8	8,5 – 10	7,5-8,2	9-10	10
Maße / dimensions	Ø x L	17 x 120	29 x 115	16 x 101	16 x 125	16 x 100	15 x 92	16 x 92	15 x 102
Anzahl p. Rotor / number p. rotor		6	6	6	6	6	6	6	6
Drehzahl / speed	RPM	4000	4000	4000	4000	4000	4000	4000	4000
RZB / RCF		2701	2701	2647	2647	2647	2647	2647	2647
Radius / radius	mm	151	151	148	148	148	148	148	148
 9 (97%)	sec	20							
 9	sec	22							
Temperatur / temperature	°C ¹⁾	- 15							
Probenerwärmung/Sample temp. rise	K ²⁾	+ 9							

1617									
Ausschwingrotor 8-fach / Swing out rotor 8-times  		1462-A							
			---						
		0509	0513						
									
Kapazität / capacity	ml	15	50						
Maße / dimensions	Ø x L	17 x 120	29 x 115						
Anzahl p. Rotor / number p. rotor		8	8						
Drehzahl / speed	RPM	5000	5000						
RZB / RCF		3857	3857						
Radius / radius	mm	138							
 9 (97%)	sec	20							
 9	sec	19							
Temperatur / temperature	°C ¹⁾	- 10							
Probenerwärmung/Sample temp. rise	K ²⁾	+ 14							

1) Tiefste erreichbare Temperatur bei maximaler Drehzahl, 1 h Laufzeit und 20°C Raumtemperatur (nur bei Kühlzentrifuge)
 2) Probenerwärmung bei maximaler Drehzahl und 1 Stunde Laufzeit (nur bei Zentrifuge ohne Kühlung)

1) Lowest possible temperature during maximum speed, 1 h running time and 20°C ambient temperature (only with cooling centrifuges)
 2) Sample temp. rise during maximum speed and 1 hour running time (only with centrifuges without cooling)

1460	1453				1453 + 1485			
Ausschwingrotor 2-fach / Swing out rotor 2-times  								
	MTP	CP	MS	DWP	PCR-Platte, 96-fach PCR plate, 96 wells	PCR-Strips		
								
Kapazität / capacity	ml					0,2		
Maße / dimensions TxBxH / DxWxH	mm	86 x 128 x 15	86 x 128 x 22	86 x 128 x 46	86 x 128 x 44,5	82x124x20	---	
Anzahl p. Rotor / number p. rotor		10	8	2	2	2	24 x 8	
Drehzahl / speed	RPM	4000	4000	4000	4000	4000	4000	
RZB / RCF		2218	2218	2218	2218	2218	2218	
Radius / radius	mm	124	124	124	124	124	124	
 9 (97%)	sec					40		
 9	sec					45		
Temperatur / temperature	°C ¹⁾					- 6		
Probenerwärmung/Sample temp. rise	K ²⁾					+ 11		

1628	1621			1122			1127		
Ausschwingrotor 12-fach / Swing out rotor 12-times   80° mit / with 1621  60° mit / with 1122  55° mit / with 1127									
		0507			2079				
									
Kapazität / capacity	ml	15	7,5 – 8,2	8,5 - 10	10	4 – 5,5	4 – 7	5	1,6 – 5,0
Maße / dimensions Ø x L	mm	17 x 100	15 x 92	16 x 100	17 x 70	15 x 75	16 x 75	12/13 x 75	13 x 75
Anzahl p. Rotor / number p. rotor		12	12	12	12	12	12	12	12
Drehzahl / speed	RPM	5000	5000	5000	5000	5000	5000	5000	5000
RZB / RCF	³⁾	4193	4193	4193	3522	3522	3522	3466	3466
Radius / radius	mm	150	150	150	126	126	126	124	124
 9 (97%)	sec					16			
 9	sec					16			
Temperatur / temperature	°C ¹⁾					- 10			
Probenerwärmung/Sample temp. rise	K ²⁾					+ 20			

1) Tiefste erreichbare Temperatur bei maximaler Drehzahl, 1 h Laufzeit und 20°C Raumtemperatur (nur bei Kühlzentrifuge)
 2) Probenerwärmung bei maximaler Drehzahl und 1 Stunde Laufzeit (nur bei Zentrifuge ohne Kühlung)
 3) Zentrifugiergefäße aus Glas nur belastbar bis RZB 4000









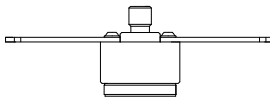

1) Lowest possible temperature during maximum speed, 1 h running time and 20°C ambient temperature (only with cooling centrifuges)
 2) Sample temp. rise during maximum speed and 1 hour running time (only with centrifuges without cooling)
 3) Centrifuge containers of glass will not stand RCF values exceeding 4000

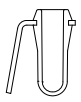
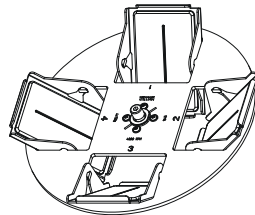







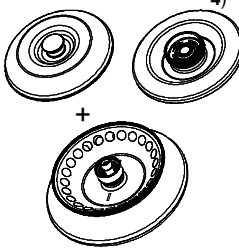

MTP Mikrotiterplatte /
Microtitre plate

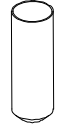
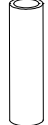
CP Kulturplatte /
Culture plate

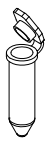
DWP Deep Well Platte /
Deep well plate

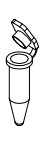
MS Micronic System /
Micronic system

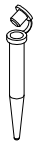
1628	1127 (50°)		1645	4345				
Ausschwingrotor 12-fach / Swing out rotor 12-times  			Ausschwingrotor 4-fach / Swing out rotor 4-times  					
						MTP		CP
								
Kapazität / capacity	ml	2,7 – 3	2,6 – 2,9	Kapazität / capacity	ml	---	---	
Maße / dimensions	Ø x L	mm	11 x 66	13 x 65	Maße / dimensions	mm	86x128x15	86x128x22
Anzahl p. Rotor / number p. rotor		12	12	Anzahl p. Rotor / number p. rotor		4	4	
Drehzahl / speed	RPM	5000	5000	Drehzahl / speed	RPM	4000	4000	
RZB / RCF		3466	3466	RZB / RCF		1896	1896	
Radius / radius	mm	124	124	Radius / radius	mm	106	106	
 9 (97%)	sec	16		 9 (97%)	sec	40		
 9	sec	16		 9	sec	43		
Temperatur / temperature	°C ¹⁾	- 15		Temperatur / temperature	°C ¹⁾	- 16		
Probenerwärmung/Sample temp. rise	K ²⁾	+ 14		Probenerwärmung/Sample temp. rise	K ²⁾	+ 17		

1420-A	3) 2031		2023		2024			
Winkelrotor 24-fach / Angle rotor 24-times  	---							
	0536	2078	---	---	---	---		
								
Kapazität / capacity	ml	2,0	1,5	0,8	0,5	0,2	0,4	
Maße / dimensions	Ø x L	mm	11 x 38	11 x 38	8 x 45	8 x 30	6 x 18	6 x 45
Anzahl p. Rotor / number p. rotor		24	24	24	24	24	24	
Drehzahl / speed	RPM	15000	15000	15000	15000	15000	15000	
RZB / RCF		21382	21382	21382	21382	21382	21382	
Radius / radius	mm	85	85	85	85	85	85	
 9 (97%)	sec			25				
 9	sec			24				
Temperatur / temperature	°C ¹⁾			- 4				
Probenerwärmung/sample temp. rise	K ²⁾			+ 18				

- 1) Tiefste erreichbare Temperatur bei maximaler Drehzahl, 1 h Laufzeit und 20°C Raumtemperatur (nur bei Kühlzentrifuge)
- 2) Probenerwärmung bei maximaler Drehzahl und 1 Stunde Laufzeit (nur bei Zentrifuge ohne Kühlung)
- 3) bei hochtouriger Zentrifugation empfohlen
- 4) 2423 phenolbeständig, autoklavierbar, mit Bioabdichtung (nach DIN EN 61010, Teil 2 – 020). Die Hinweise für Bio-Sicherheitssysteme in den Kapiteln "Sicherheitshinweise" und "Pflege und Wartung" beachten.











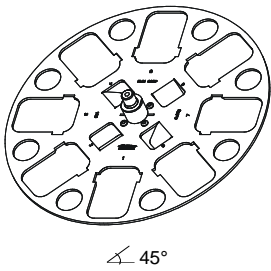

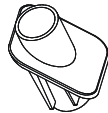
2425 autoklavierbar, mit Bioabdichtung (nach DIN EN 61010, Teil 2 – 020). Die Hinweise für Bio-Sicherheitssysteme in den Kapiteln "Sicherheitshinweise" und "Pflege und Wartung" beachten











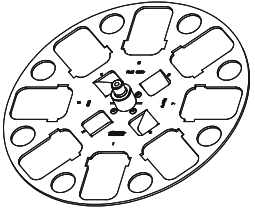

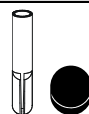
- 1) Lowest possible temperature during maximum speed, 1 h running time and 20°C ambient temperature (only with cooling centrifuges)
- 2) Sample temp. rise during maximum speed and 1 hour running time (only with centrifuges without cooling)
- 3) recommended for high-speed centrifugation
- 4) 2423 phenol resistant, autoclavable, with bio-containment (in conformity with DIN EN 61010, part 2 – 020). Observe the notes for bio safety systems in chapters "Notes on safety" and "Maintenance and servicing".

2425 autoclavable, with bio-containment (in conformity with DIN EN 61010, part 2 – 020). Observe the notes for bio safety systems in chapters "Notes on safety" and "Maintenance and servicing".

MTP Mikrotiterplatten /
Microtitre plate









CP Kulturplatte /
Culture plate

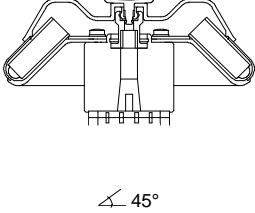
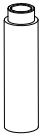



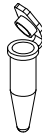



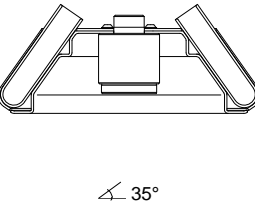
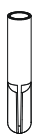
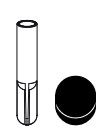

1418	1467				1468				
Winkelrotor 8-fach / Angle rotor 8-times  45°									
	0716		E2109		E2110				
									
	0507	---	0518	0509	0546	---	0513		
									
Kapazität / capacity	ml	15	12	15	15	50	50	50	
Maße / dimensions \varnothing x L	mm	17 x 100	17 x 100	17 x 100	17 x 120	29 x 107	29 x 115	29 x 115	
Anzahl p. Rotor / number p. rotor		32	32	32	32	8	8	8	
Drehzahl / speed	RPM	4500	4500	4500	4500	4500	4500	4500	
RZB / RCF		3215	3215	3215	3283	3147	3147	3147	
Radius / radius	mm	142	142	142	145	139	139	139	
 9 (97%)	sec				30				
 9	sec				31				
Temperatur / temperature	°C ¹⁾				- 5				
Probenerwärmung/Sample temp. rise	K ²⁾				+ 20				

1418	1467								
Winkelrotor 8-fach / Angle rotor 8-times  45°									
	1054-A /0701	1054-A							
									
		0553							
									
Kapazität / capacity	ml	4	5	1,1 – 1,4	2,7 - 3	2,6 – 2,9	1,6 - 5	5	
Maße / dimensions \varnothing x L	mm	12 x 60	12 x 75	8 x 66	11 x 66	13 x 65	13 x 75	13 x 75	
Anzahl p. Rotor / number p. rotor		32	32	32	32	32	32	32	
Drehzahl / speed	RPM	4500	4500	4500	4500	4500	4500	4500	
RZB / RCF		2694	2762	2762	2762	2762	2762	2762	
Radius / radius	mm	119	122	122	122	122	122	122	
 (97%)	sec				30				
 1	sec				31				
Temperatur / temperature	°C ¹⁾				- 5				
Probenerwärmung/Sample temp. rise	K ²⁾				+ 20				

1) Tiefste erreichbare Temperatur bei maximaler Drehzahl, 1 h Laufzeit und 20°C Raumtemperatur (nur bei Kühlzentrifuge)
 2) Probenerwärmung bei maximaler Drehzahl und 1 Stunde Laufzeit (nur bei Zentrifuge ohne Kühlung)











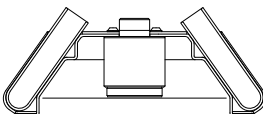

1) Lowest possible temperature during maximum speed, 1 h running time and 20°C ambient temperature (only with cooling centrifuges)
 2) Sample temp. rise during maximum speed and 1 hour running time (only with centrifuges without cooling)







1612		2024		2023		3) 2031					
 <p>Winkelrotor 12-fach / Angle rotor 12-times</p> <p>45°</p>							---				
		---		---							
	Kapazität / capacity	ml	0,2	0,4	0,5	0,8	1,5	2,0			
Maße / dimensions	Ø x L	mm	6 x 18	6 x 45	8 x 30	8 x 45	11 x 38	11 x 38			
Anzahl p. Rotor / number p. rotor			12	12	12	12	12				
Drehzahl / speed	RPM		15000	15000	15000	15000	15000				
RZB / RCF			16602	16602	16602	16602	16602				
Radius / radius	mm		66	66	66	66	66				
 9 (97%)	sec		25								
 9	sec		23								
Temperatur / temperature	°C ¹⁾		- 10								
Probenerwärmung/Sample temp. rise	K ²⁾		+ 8								

1613		1054-A					1054-A /0701				
 <p>Winkelrotor 12-fach / Angle rotor 12-times</p> <p>35°</p>											
		---		0501							
											
Kapazität / capacity	ml	5	1,6 – 5,0	6	2,6 – 2,9	2,7 – 3	1,1 – 1,4	4	8,5 - 10	8	
Maße / dimensions	Ø x L	mm	12/13 x 75	13 x 75	12 x 82	13 x 65	11 x 66	8 x 66	12 x 60	16 x 100	16 x 125
Anzahl p. Rotor / number p. rotor			12	12	12	12	12	12	12	6	
Drehzahl / speed	RPM		6000	6000	6000	6000	6000	6000	6000	6000	
RZB / RCF			3300	3300	3300	3300	3300	3260	4146	4146	
Radius / radius	mm		82	82	82	82	82	81	103	103	
 9 (97%)	sec		15								
 9	sec		15								
Temperatur / temperature	°C ¹⁾		- 16								
Probenerwärmung/Sample temp. rise	K ²⁾		+ 4								

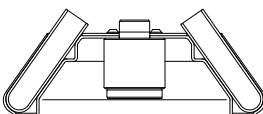
- 1) Tiefste erreichbare Temperatur bei maximaler Drehzahl, 1 h Laufzeit und 20°C Raumtemperatur (nur bei Kühlzentrifuge)
- 2) Probenerwärmung bei maximaler Drehzahl und 1 Stunde Laufzeit (nur bei Zentrifuge ohne Kühlung)
- 3) bei hochtouriger Zentrifugation empfohlen





- 1) Lowest possible temperature during maximum speed, 1 h running time and 20°C ambient temperature (only with cooling centrifuges)
- 2) Sample temp. rise during maximum speed and 1 hour running time (only with centrifuges without cooling)
- 3) recommended for high-speed centrifugation





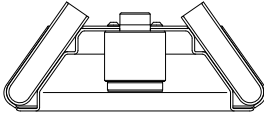



1613								
Winkelrotor 12-fach / Angle rotor 12-times  							SK 19/85-4	
								
Kapazität / capacity ml	4,5 - 5	4,9	7,5 - 8,2	9 - 10	10	4 - 5,5	1,6 - 5	4 - 7
Maße / dimensions Ø x L mm	11 x 92	13 x 90	15 x 92	16 x 92	15 x 102	15 x 75	13 x 75	16 x 75
Anzahl p. Rotor / number p. rotor	12	12	12	12	12	12	12	12
Drehzahl / speed RPM	6000	6000	6000	6000	6000	6000	6000	6000
RZB / RCF	4146	4146	4146	4146	4146	3663	3663	3663
Radius / radius mm	103	103	103	103	103	91	91	91
 9 (97%) sec					15			
 9 sec					15			
Temperatur / temperature °C ¹⁾					- 16			
Probenerwärmung/Sample temp. rise K ²⁾					+ 4			







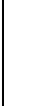



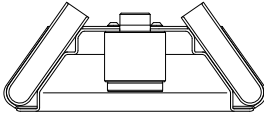

1613								
Winkelrotor 12-fach / Angle rotor 12-times  					6305			
				SK 1/89			SK 73/74	
		0507	0509	---		2078	0536	
Kapazität / capacity ml	4 - 7	15	15	0,8	4	1,5	2,0	
Maße / dimensions Ø x L mm	13 x 100	17 x 100	17 x 120	8 x 45	10 x 88	11 x 38	11 x 38	
Anzahl p. Rotor / number p. rotor	12	12	6	12	12	12	12	
Drehzahl / speed RPM	6000	6000	6000	6000	6000	6000	6000	
RZB / RCF ³⁾	4146	4146	4146	2576	3502	2737	2737	
Radius / radius mm	103	103	103	64	87	68	68	
 9 (97%) sec					15			
 9 sec					15			
Temperatur / temperature °C ¹⁾					- 16			
Probenerwärmung/Sample temp. rise K ²⁾					+ 4			

1) Tiefste erreichbare Temperatur bei maximaler Drehzahl, 1 h Laufzeit und 20°C Raumtemperatur (nur bei Kühlzentrifuge)
 2) Probenerwärmung bei maximaler Drehzahl und 1 Stunde Laufzeit (nur bei Zentrifuge ohne Kühlung)
 3) Zentrifugiergefäße aus Glas nur belastbar bis RZB 4000

1) Lowest possible temperature during maximum speed, 1 h running time and 20°C ambient temperature (only with cooling centrifuges)
 2) Sample temp. rise during maximum speed and 1 hour running time (only with centrifuges without cooling)
 3) Centrifuge containers of glass will not stand RCF values exceeding 4000

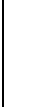









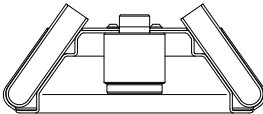

1615		1054-A					1054-A /0701			
Winkelrotor 12-fach / Angle rotor 12-times  $\angle 35^\circ$										











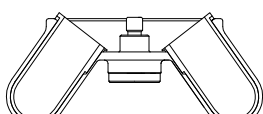

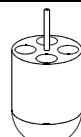



										
Kapazität / capacity	ml	5	1,6 – 5	6	2,6 – 2,9	2,7 x 3	1,1 – 1,4	4	8,5 - 10	8
Maße / dimensions \varnothing x L	mm	12/13 x 75	13 x 75	12 x 82	13 x 65	11 x 66	8 x 66	12 x 60	16 x 100	16 x 125
Anzahl p. Rotor / number p. rotor		12	12	12	12		12	12	12	6
Drehzahl / speed	RPM	12000	12000	12000	12000		12000	12000	12000	12000
RZB / RCF	³⁾	13201	13201	13201	13201		13201	13040	16582	16582
Radius / radius	mm	82	82	82	82		82	81	103	103
 9 (97%)	sec									40
 9	sec									40
Temperatur / temperature	$^\circ\text{C}$ ¹⁾									- 2
Probenerwärmung/Sample temp. rise	K ²⁾									+ 14

1615		SK 19/85-4															
Winkelrotor 12-fach / Angle rotor 12-times  $\angle 35^\circ$																	
Kapazität / capacity	ml	4,5 - 5	4,9	7,5 – 8,2	9 – 10	10	4 – 5,5	1,6 - 5	4 - 7								
Maße / dimensions \varnothing x L	mm	11 x 92	13 x 90	15 x 92	16 x 92	15 x 102	15 x 75	13 x 75	16 x 75								
Anzahl p. Rotor / number p. rotor		12	12	12	12	12	12	12	12								
Drehzahl / speed	RPM	12000	12000	12000	12000	12000	12000	12000	12000								
RZB / RCF		16582	16582	16582	16582	16582	14650	14650	14650								
Radius / radius	mm	103	103	103	103	103	91	91	91								
 9 (97%)	sec									40							
 9	sec									40							
 0	sec									840							
Temperatur / temperature	$^\circ\text{C}$ ¹⁾									- 2							
Probenerwärmung/Sample temp. rise	K ²⁾									+ 14							

- 1) Tiefste erreichbare Temperatur bei maximaler Drehzahl, 1 h Laufzeit und 20°C Raumtemperatur (nur bei Kühlzentrifuge)
- 2) Probenerwärmung bei maximaler Drehzahl und 1 Stunde Laufzeit (nur bei Zentrifuge ohne Kühlung)
- 3) Zentrifugiergefäße aus Glas nur belastbar bis RZB 4000











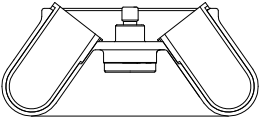
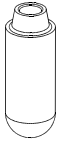

- 1) Lowest possible temperature during maximum speed, 1 h running time and 20°C ambient temperature (only with cooling centrifuges)
- 2) Sample temp. rise during maximum speed and 1 hour running time (only with centrifuges without cooling)
- 3) Centrifuge containers of glass will not stand RCF values exceeding 4000

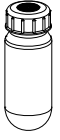



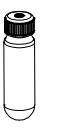

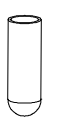
1615									
Winkelrotor 12-fach / Angle rotor 12-times  						6305			
					SK 1/89		SK 73/74		
		0507	0509	---			2078	0536	
									
Kapazität / capacity	ml	4 - 7	15	15	0,8	4	1,5	2,0	
Maße / dimensions	Ø x L	mm	13 x 100	17 x 100	17 x 120	8 x 45	10 x 88	11 x 38	11 x 38
Anzahl p. Rotor / number p. rotor		12	12	6	12	12	12	12	
Drehzahl / speed	RPM	12000	12000	12000	12000	12000	12000	12000	
RZB / RCF	³⁾	16582	16582	16582	10303	14006	10947	10947	
Radius / radius	mm	103	103	103	64	87	68	68	
 9 (97%)	sec				40				
 9	sec				40				
Temperatur / temperature	°C ¹⁾				- 2				
Probenerwärmung/Sample temp. rise	K ²⁾				+ 14				

1620A		1449		1448	1451					
Winkelrotor 6-fach / Angle rotor 6-times  										
		2078	0536	---	---	0507				
										
Kapazität / capacity	ml	1,5	2,0	3	10	15	7,5 - 8,2	9 - 10	10	8,5 - 10
Maße / dimensions	Ø x L	mm	11 x 38	10 x 60	16 x 80	17 x 100	15 x 92	16 x 92	15 x 102	16 x 100
Anzahl p. Rotor / number p. rotor		24	24	12	6	6	6	6	6	6
Drehzahl / speed	RPM	9000	9000	9000	9000	9000	9000	9000	9000	9000
RZB / RCF	³⁾	9146	9146	8784	8784	8784	8784	8784	8784	8784
Radius / radius	mm	101	101	97	97	97	97	97	97	97
 9 (97%)	sec				30					
 9	sec				30					
Temperatur / temperature	°C ¹⁾				- 11					
Probenerwärmung/Sample temp. rise	K ²⁾				+ 8					

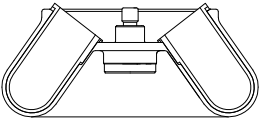
- 1) Tiefste erreichbare Temperatur bei maximaler Drehzahl, 1 h Laufzeit und 20°C Raumtemperatur (nur bei Kühlzentrifuge)
- 2) Probenerwärmung bei maximaler Drehzahl und 1 Stunde Laufzeit (nur bei Zentrifuge ohne Kühlung)
- 3) Zentrifugiergefäße aus Glas nur belastbar bis RZB 4000











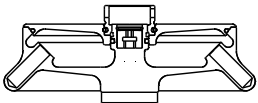

- 1) Lowest possible temperature during maximum speed, 1 h running time and 20°C ambient temperature (only with cooling centrifuges)
- 2) Sample temp. rise during maximum speed and 1 hour running time (only with centrifuges without cooling)
- 3) Centrifuge containers of glass will not stand RCF values exceeding 4000



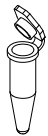



1620A										
Winkelrotor 6-fach / Angle rotor 6-times  $\angle 35^\circ$	---	1466	1454	1646	1447	1446	1463			
										
	0547	0509	0513	0513	0545	0546	0548	0521		
										
Kapazität / capacity	ml	85	15	50	50	30	50	50	50	
Maße / dimensions	Ø x L	mm	38 x 106	17 x 120	29 x 115	29 x 115	26 x 95	29 x 107	35 x 105	34 x 100
Anzahl p. Rotor / number p. rotor		6	6	3	6	6	6	6	6	
Drehzahl / speed	RPM	9000	9000	9000	9000	9000	9000	9000	9000	
RZB / RCF	³⁾	9418	8965	8965	8965	8603	9056	9327	9327	
Radius / radius	mm	104	99	99	99	95	100	103	103	
 9 (97%)	sec					30				
 9	sec					30				
Temperatur / temperature	°C ¹⁾					- 11				
Probenerwärmung/Sample temp. rise	K ²⁾					+ 8				

1620A										
Winkelrotor 6-fach / Angle rotor 6-times  $\angle 35^\circ$	SK 63.98									
	---	0501								
										
Kapazität / capacity	ml	5	6	2,6 - 2,9	1,6 - 5,0					
Maße / dimensions	Ø x L	mm	12/13 x 75	12 x 82	13 x 65	13 x 75				
Anzahl p. Rotor / number p. rotor		12	12	12	12					
Drehzahl / speed	RPM	9000	9000	9000	9000					
RZB / RCF	³⁾	8512	8512	8512	8512					
Radius / radius	mm	94	94	94	94					
 9 (97%)	sec					30				
 9	sec					30				
Temperatur / temperature	°C ¹⁾					- 11				
Probenerwärmung/Sample temp. rise	K ²⁾					+ 8				

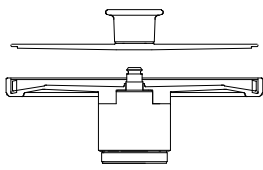
- 1) Tiefste erreichbare Temperatur bei maximaler Drehzahl, 1 h Laufzeit und 20°C Raumtemperatur (nur bei Kühlzentrifuge)
- 2) Probenerwärmung bei maximaler Drehzahl und 1 Stunde Laufzeit (nur bei Zentrifuge ohne Kühlung)
- 3) Zentrifugiergefäße aus Glas nur belastbar bis RZB 4000











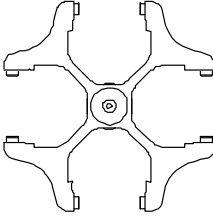

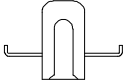

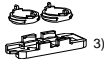
- 1) Lowest possible temperature during maximum speed, 1 h running time and 20°C ambient temperature (only with cooling centrifuges)
- 2) Sample temp. rise during maximum speed and 1 hour running time (only with centrifuges without cooling)
- 3) Centrifuge containers of glass will not stand RCF values exceeding 4000











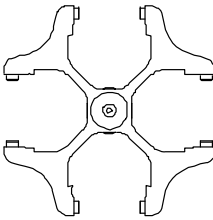

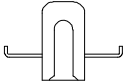
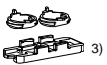

1689-A									
Winkelrotor 30-fach / Angle rotor 30-times   mit Bioabdichtung / with bio-containment ⁵⁾		3) 2031	2023		2024				
		----							
		0536	2078						
									
Kapazität / capacity	ml	2,0	1,5	0,8	0,5	0,4	0,2		
Maße / dimensions	∅ x L mm	11 x 38	11 x 38	8 x 45	8 x 30	6 x 45	6 x 18		
Anzahl p. Rotor / number p. rotor		30	30	30	30	30	30		
Drehzahl / speed	RPM	14000	14000	14000	14000	14000	14000		
RZB / RCF		21255	21255	21255	21255	21255	21255		
Radius / radius	mm	97	97	97	97	97	97		
 9 (97%)	sec				35				
 9	sec				31				
Temperatur / temperature	°C ¹⁾				- 0				
Probenerwärmung/Sample temp. rise	K ⁴⁾				+ 20				

1650								
Hämatokritrotor 24-fach / Haematocrite rotor 24-times 								
		2077 Verschlusskitt / sealing putty						
		1071	1072	2074				
								
Kapazität / capacity	ml							
Maße / dimensions	∅ x L mm	1,4 x 75	1,6 x 75	1,4 x 75				
Anzahl p. Rotor / number p. rotor		24	24	24				
Drehzahl / speed	RPM	15000	15000	15000				
RZB / RCF		21382	21382	21382				
Radius / radius	mm	85	85	85				
 9 (97%)	sec	13						
 9	sec	9						
Temperatur / temperature	°C ¹⁾	- 1						
Probenerwärmung/Sample temp. rise	K ²⁾	+ 19						

- 1) Tiefste erreichbare Temperatur bei maximaler Drehzahl, 1 h Laufzeit und 20°C Raumtemperatur (nur bei Kühlzentrifuge)
- 2) Probenerwärmung bei maximaler Drehzahl und 1 Stunde Laufzeit (nur bei Zentrifuge ohne Kühlung)
- 3) bei hochtouriger Zentrifugation empfohlen
- 4) Bei einer Laufzeit länger als 15 min. beträgt die Probenerwärmung > 20°K (nur bei Zentrifuge ohne Kühlung)
- 5) Nach DIN EN 61010, Teil 2 – 020. Die Hinweise für Bio-Sicherheitssysteme in den Kapiteln "Sicherheitshinweise" und "Pflege und Wartung" beachten





- 1) Lowest possible temperature during maximum speed, 1 h running time and 20°C ambient temperature (only with cooling centrifuges)
- 2) Sample temp. rise during maximum speed and 1 hour running time (only with centrifuges without cooling)
- 3) recommended for high-speed centrifugation
- 4) With running time longer than 15 min., the sample temp. rise up will be > 20°K (only with cooling centrifuges)
- 5) in conformity with DIN EN 61010, part 2 – 020. Observe the notes for bio safety systems in chapters "Notes on safety" and "Maintenance and servicing".





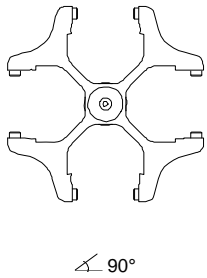
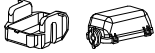

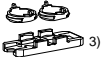



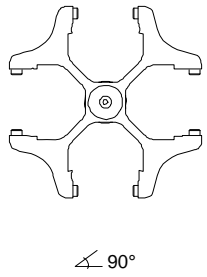



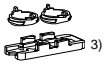

1494		1452							
Ausschwingrotor 4-fach / Swing out rotor 4-times  									
		1662						1670	
									
		1663	1664	1665	1666	1667	1668	1663	1664
									
Kapazität / capacity	ml	1	2	4	8	3 x 2	4 x 1	1	2
Maße / dimensions	∅ / A	6,2 / 30	8,7 / 60	12,4 / 120	17,5 / 240	8,7 / 60	6,2 / 30	6,2 / 30	8,7 / 60
Anzahl p. Rotor / number p. rotor		4	4	4	4	4	4	4	4
Filterkarten / filter cards		1675	1675	1675	1676	1677	1678	1692	1692
Drehzahl / speed	RPM	5000	5000	5000	5000	5000	5000	5000	5000
RZB / RCF		2879	2879	2879	2879	2879	2879	2879	2879
Radius / radius	mm	103	103	103	103	103	103	103	103
 9 (97%)	sec	30							
 9	sec	32							
Temperatur / temperature	°C ¹⁾	- 10							
Probenerwärmung/Sample temp. rise	K ²⁾	+ 12							

1494		1452								
Ausschwingrotor 4-fach / Swing out rotor 4-times  										
		1670				1285	1470			
										
		1665	1666	1667	1668		1471	1475		
										
Kapazität / capacity	ml	4	8	3 x 2	4 x 1	Objektträger/ object slide	1 x 8	2 x 8		
Maße / dimensions	∅ / A	12,4 / 120	17,5 / 240	8,7 / 60	6,2 / 30	26 / 76	17,5 / 240	17,5 / 240		
Anzahl p. Rotor / number p. rotor		4	4	4	4	24	4	4		
Filterkarten / filter cards		1692	1691	1694	1693	---	---	---		
Drehzahl / speed	RPM	5000	5000	5000	5000	5000	5000	5000		
RZB / RCF		2879	2879	2879	2879	2767	2739	2739		
Radius / radius	mm	103	103	103	103	99	98	98		
 9 (97%)	sec	30								
 9	sec	32								
Temperatur / temperature	°C ¹⁾	- 10								
Probenerwärmung/Sample temp. rise	K ²⁾	+ 12								

- 1) Tiefste erreichbare Temperatur bei maximaler Drehzahl, 1 h Laufzeit und 20°C Raumtemperatur (nur bei Kühlzentrifuge)
- 2) Probenerwärmung bei maximaler Drehzahl und 1 Stunde Laufzeit (nur bei Zentrifuge ohne Kühlung)
- 3) Objektträger nur belastbar bis RZB 1100









- 1) Lowest possible temperature during maximum speed, 1 h running time and 20°C ambient temperature (only with cooling centrifuges)
- 2) Sample temp. rise during maximum speed and 1 hour running time (only with centrifuges without cooling)
- 3) Object slide will not stand RCF values exceeding 1100

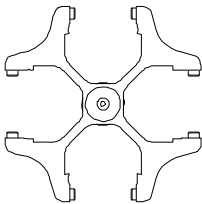









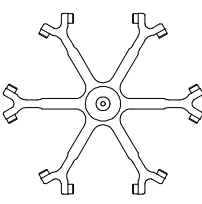

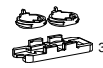
1624 Ausschwingrotor 4-fach / Swing out rotor 4-times  $\angle 90^\circ$	1660 1661		1662				1670	
								
	1663	1664	1665	1666	1667	1668	1663	1664
Kapazität / capacity ml	1	2	4	8	3 x 2	4 x 1	1	2
Maße / dimensions Ø / A mm ²	6,2 / 30	8,7 / 60	12,4 / 120	17,5 / 240	8,7 / 60	6,2 / 30	6,2 / 30	8,7 / 60
Anzahl p. Rotor / number p. rotor	4	4	4	4	4	4	4	4
Filterkarten / filter cards	1675	1675	1675	1676	1677	1678	1692	1692
Drehzahl / speed RPM	4000	4000	4000	4000	4000	4000	4000	4000
RZB / RCF	1646	1646	1646	1646	1646	1646	1646	1646
Radius / radius mm	92	92	92	92	92	92	92	92
 9 (97%) sec	20							
 9 sec	25							
Temperatur / temperature °C ¹⁾	- 16							
Probenerwärmung/Sample temp. rise K ²⁾	+ 3							

1624 Ausschwingrotor 4-fach / Swing out rotor 4-times  $\angle 90^\circ$	1660 1661		1660		1680			
								
	1670				1285	1662		
					 nur ohne Deckel 1661 / only without lid 1661			
1665	1666	1667	1668		1671	1672	1673	
								
Kapazität / capacity ml	4	8	3 x 2	4 x 1	Objektträger Object slide	[1] 0,5	[1] 0,5	[1] 0,5
Maße / dimensions Ø / A mm ²	12,4 / 120	17,5 / 240	8,7 / 60	6,2 / 30	26 / 76	6,2 / 30	8,7 / 60	12,4 / 120
Anzahl p. Rotor / number p. rotor	4	4	4	4	24	4	4	4
Filterkarten / filter cards	1692	1691	1694	1693	---	[1] 1696	[1] 1697	[1] 1698
Drehzahl / speed RPM	4000	4000	4000	4000	4000	4000	4000	4000
RZB / RCF	1646	1646	1646	1646	1520	1467	1467	1467
Radius / radius mm	92	92	92	92	88	82	82	82
 9 (97%) sec	20							
 9 sec	25							
 0 sec	390							
Temperatur / temperature °C ¹⁾	- 16							
Probenerwärmung/Sample temp. rise K ²⁾	+ 3							

- 1) Tiefste erreichbare Temperatur bei maximaler Drehzahl, 1 h Laufzeit und 20°C Raumtemperatur (nur bei Kühlzentrifuge)
 - 2) Probenerwärmung bei maximaler Drehzahl und 1 Stunde Laufzeit (nur bei Zentrifuge ohne Kühlung)
 - 3) Objektträger nur belastbar bis RZB 1100
- [1] Einschritt-Methode











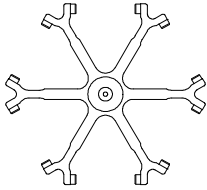

- 1) Lowest possible temperature during maximum speed, 1 h running time and 20°C ambient temperature (only with cooling centrifuges)
 - 2) Sample temp. rise during maximum speed and 1 hour running time (only with centrifuges without cooling)
 - 3) Object slide will not stand RCF values exceeding 1100
- [1] One-step method

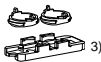





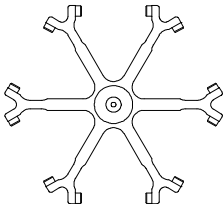

1624		1660		1661						
Ausschwingrotor 4-fach / Swing out rotor 4-times  90°										
		1470 								
		1471	1475							
										
Kapazität / capacity	ml	1 x 8	2 x 8							
Maße / dimensions Ø / A	mm ²	17,5 / 240	17,5 / 240							
Anzahl p. Rotor / number p. rotor		4	4							
Filterkarten / filter cards		---	---							
Drehzahl / speed	RPM	4000	4000							
RZB / RCF		1556	1556							
Radius / radius	mm	87	87							
 9 (97%)	sec	20								
 9	sec	25								
 0	sec	390								
Temperatur / temperature	°C ¹⁾	- 16								
Probenerwärmung/Sample temp. rise	K ²⁾	+ 3								

1626		1660		1661					
Ausschwingrotor 6-fach / Swing out rotor 6-times  90°									
		1662 						1670  ³⁾	
		1663	1664	1665	1666	1667	1668	1663	1664
									
Kapazität / capacity	ml	1	2	4	8	3 x 2	4 x 1	1	2
Maße / dimensions Ø / A	mm ²	6,2 / 30	8,7 / 60	12,4 / 120	17,5 / 240	8,7 / 60	6,2 / 30	6,2 / 30	8,7 / 60
Anzahl p. Rotor / number p. rotor		6	6	6	6	6	6	6	6
Filterkarten / filter cards		1675	1675	1675	1676	1677	1678	1692	1692
Drehzahl / speed	RPM	4000	4000	4000	4000	4000	4000	4000	4000
RZB / RCF		2039	2039	2039	2039	2039	2039	2039	2039
Radius / radius	mm	114	114	114	114	114	114	114	114
 9 (97%)	sec	20							
 9	sec	22							
Temperatur / temperature	°C ¹⁾	- 16							
Probenerwärmung/Sample temp. rise	K ²⁾	+ 7							

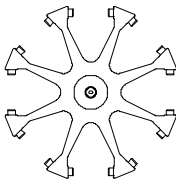
- 1) Tiefste erreichbare Temperatur bei maximaler Drehzahl, 1 h Laufzeit und 20°C Raumtemperatur (nur bei Kühlzentrifuge)
- 2) Probenerwärmung bei maximaler Drehzahl und 1 Stunde Laufzeit (nur bei Zentrifuge ohne Kühlung)
- 3) Objektträger nur belastbar bis RZB 1100

- 1) Lowest possible temperature during maximum speed, 1 h running time and 20°C ambient temperature (only with cooling centrifuges)
- 2) Sample temp. rise during maximum speed and 1 hour running time (only with centrifuges without cooling)
- 3) Object slide will not stand RCF values exceeding 1100

1626	1660 1661				1660	1680				
Ausschwingrotor 6-fach / Swing out rotor 6-times  90°										
	1670 					1285  nur ohne Deckel 1661 / only without lid 1661	1662 			
	1665	1666	1667	1668		1671	1672	1673		
										
Kapazität / capacity ml	4	8	3 x 2	4 x 1	Objekträger / Object slide	[1] 0,5	[1] 0,5	[1] 0,5		
Maße / dimensions Ø / A mm²	12,4 / 120	17,5 / 240	8,7 / 60	6,2 / 30	26 / 76	6,2 / 30	8,7 / 60	12,4 / 120		
Anzahl p. Rotor / number p. rotor	6	6	6	6	36	6	6	6		
Filterkarten / filter cards	1692	1691	1694	1693	---	[1] 1696	[1] 1697	[1] 1698		
Drehzahl / speed RPM	4000	4000	4000	4000	4000	4000	4000	4000		
RZB / RCF	2039	2039	2039	2039	1914	1842	1842	1842		
Radius / radius mm	114	114	114	114	107	103	103	103		
9 (97%) sec	20									
9 sec	22									
0 sec	330									
Temperatur / temperature °C ¹⁾	- 16									
Probenerwärmung / Sample temp. rise K ²⁾	+ 7									

1626	1660 + 1661		1648		1680		
Ausschwingrotor 6-fach / Swing out rotor 6-times  90°			Ausschwingrotor 8-fach / Swing out rotor 8-times  90°				
	1470 				1662 		
	1471	1475			1671 1672 1673		
							
Kapazität / capacity ml	1 x 8	2 x 8	Kapazität / capacity ml		[1] 0,5	[1] 0,5	[1] 0,5
Maße / dimensions Ø x L mm	17,5 / 240	17,5 / 240	Maße / dimensions Ø x L mm		6,2 / 30	8,7 / 60	12,4 / 120
Anzahl p. Rotor / number p. rotor	6	6	Anzahl p. Rotor / number p. rotor		8	8	8
Filterkarten / filter cards	---	---	Filterkarten / filter cards		[1] 1696	[1] 1697	[1] 1698
Drehzahl / speed RPM	4000	4000	Drehzahl / speed RPM		4000	4000	4000
RZB / RCF	1950	1950	RZB / RCF		2218	2218	2218
Radius / radius mm	109	109	Radius / radius mm		124	124	124
9 (97%) sec	20		9 (97%) sec		20		
9 sec	22		9 sec		17		
Temperatur / temperature °C ¹⁾	- 16		Temperatur / temperature °C ¹⁾		- 16		
Probenerwärmung / Sample temp. rise K ²⁾	+ 7		Probenerwärmung / Sample temp. rise K ²⁾		+ 13		

1) Tiefste erreichbare Temperatur bei maximaler Drehzahl, 1 h Laufzeit und 20°C Raumtemperatur (nur bei Kühlzentrifuge)
 2) Probenerwärmung bei maximaler Drehzahl und 1 Stunde Laufzeit (nur bei Zentrifuge ohne Kühlung)
 3) Objekträger nur belastbar bis RZB 1100
 [1] Einschritt-Methode

1) Lowest possible temperature during maximum speed, 1 h running time and 20°C ambient temperature (only with cooling centrifuges)
 2) Sample temp. rise during maximum speed and 1 hour running time (only with centrifuges without cooling)
 3) Object slide will not stand RCF values exceeding 1100
 [1] One-step method